

MAC 1200/1200 ST

Operator's Manual

Software Version 6

2012250-021

Revision C



GE Medical Systems
Information Technologies

gemedical.com

NOTE: The information in this manual only applies to MAC 1200/1200 ST software version 6. It does not apply to earlier software versions. Due to continuing product innovation, specifications in this manual are subject to change without notice.

Listed below are GE Medical Systems *Information Technologies* trademarks. All other trademarks contained herein are the property of their respective owners.

900 SC, ACCUSKETCH, AccuVision, APEX, AQUA-KNOT, ARCHIVIST, Autoseq, BABY MAC, C Qwik Connect, CardioServ, CardioSmart, CardioSys, CardioWindow, CASE, CD TELEMETRY, CENTRA, CHART GUARD, CINE 35, CORO, COROLAN, COROMETRICS, Corometrics Sensor Tip, CRG PLUS, DASH, Digistore, Digital DATAQ, E for M, EAGLE, Event-Link, FMS 101B, FMS 111, HELLIGE, IMAGE STORE, INTELLIMOTION, IQA, LASER SXP, MAC, MAC-LAB, MACTRODE, MANAGED USE, MARQUETTE, MARQUETTE MAC, MARQUETTE MEDICAL SYSTEMS, MARQUETTE UNITY NETWORK, MARS, MAX, MEDITEL, MEI, MEI in the circle logo, MEMOPOINT, MEMOPOINT C, MINISTORE, MINNOWS, Monarch 8000, MULTI-LINK, MULTISCRIPTOR, MUSE, MUSE CV, Neo-Trak, NEUROSCRIPT, OnlineABG, OXYMONITOR, Pres-R-Cuff, PRESSURE-SCRIBE, QMI, QS, Quantitative Medicine, Quantitative Sentinel, RAC RAMS, RSVP, SAM, SEER, SILVERTRACE, SOLAR, SOLARVIEW, Spectra 400, Spectra-Overview, Spectra-Tel, ST GUARD, TRAM, TRAM-NET, TRAM-RAC, TRAMSCOPE, TRIM KNOB, Triline, UNION STATION, UNITY logo, UNITY NETWORK, Vari-X, Vari-X Cardiomatic, VariCath, VARIDEX, VAS, and Vision Care Filter are trademarks of GE Medical Systems *Information Technologies* registered in the United States Patent and Trademark Office.

12SL, 15SL, Access, AccuSpeak, ADVANTAGE, BAM, BODYTRODE, Cardiomatic, CardioSpeak, CD TELEMETRY[®]-LAN, CENTRALSCOPE, Corolation, EDIC, EK-Pro, Event-Link Cirrus, Event-Link Cumulus, Event-Link Nimbus, HI-RES, ICMMS, IMAGE VAULT, IMPACT.wf, INTER-LEAD, IQA, LIFEWATCH, Managed Use, MARQUETTE PRISM, MARQUETTE[®] RESPONDER, MENTOR, MicroSmart, MMS, MRT, MUSE CardioWindow, NST PRO, NAUTILUS, O₂SENSOR, Octanet, OMRS, Phi-Res, Premium, Prism, QUIK CONNECT V, QUICK CONNECT, QT Guard, SMART-PAC, SMARTLOOK, Spiral Lok, Sweetheart, UNITY, Universal, Waterfall, and Walkmom are trademarks of GE Medical Systems *Information Technologies*.

© GE Medical Systems *Information Technologies*, 2004. All rights reserved.

CE Marking Information



Compliance

The MAC 1200/1200 ST bears CE mark “CE-0459”, notified body GMED, indicating its conformity with the provisions of the Council Directive 93/42/EEC concerning medical devices and fulfills the essential requirements of Annex I of this directive.

Any other directive(s) and all the standards the product complies to are listed in the general information of the operator manual for the product following this page.

The country of manufacture can be found on the equipment labeling.

The product is in radio-interference protection class A in accordance with EN 55011.

The product complies with the requirements of standard EN 60601-1-2 “Electromagnetic Compatibility - Medical Electrical Equipment”.

The safety and effectiveness of this device has been verified against previously distributed devices. Although all standards applicable to presently marketed devices may not be appropriate for prior devices (i.e. electromagnetic compatibility standards), this device will not impair the safe and effective use of those previously distributed devices. See user’s information.

Exceptions

The MAC 1200/1200 ST EMC: Immunity Performance

Users should be aware of known RF sources, such as radio or TV stations and hand-held or mobile two-way radios, and consider them when installing a medical device or system.

Be aware that adding accessories or components, or modifying the medical device or system may degrade the EMI performance. Consult with qualified personnel regarding changes to the system configuration.

General Information

- The device is designed to comply with IEC 60601 requirements. It is a protection class I device.
- The CE mark covers only the accessories listed in the chapter “Order Information”.
- The information contained in this manual reflects software version 6.

Contents

1

The Basics	1-1
About This Manual	1-3
Manual Purpose	1-3
Intended Audience	1-4
Definitions	1-4
Illustrations and Names	1-5
Revision History	1-5
Safety Information	1-6
Definitions	1-7
Underwriters Laboratories, Inc.	1-10
Biocompatibility	1-11
Literature	1-11
Service Information	1-12
Requirements	1-12

2

Controls and Indicators	2-1
General Information	2-3
MAC 1200 Control Panels	2-3
MAC 1200 Keyboard	2-4
MAC 1200 ST Keyboard	2-5
Symbols	2-6

3

Operating and Performance Tests	3-1
Power Supply	3-3
Installation and Mains Connection	3-4
Performance Check	3-5
Contrast Adjustment	3-6
System Setup	3-7
Connecting Peripheral Equipment	3-9

4

Preparing for ECG Recording	4-1
Connecting the Patient Cable	4-3
Electrode Application	4-4
Applying Plate Electrodes (Limbs)	4-4
Applying Suction Electrodes (Chest)	4-4
Electrode Placement for Standard Leads (I, II, III, aVR, aVL, aVF, V1...V6)	4-5
Electrode Placement for Nehb Leads	4-7
Artifact Due to Poor Electrode Application	4-9
Entering Patient Data	4-11
New Patient	4-13
Last Name, First Name	4-13
Date of Birth	4-13
Patient ID	4-13
Chest Pain	4-14
Pacemaker	4-14
Gender/Race	4-14
Height/Weight	4-14
Systolic BP/Diastolic BP	4-14
Ordering Physician / Referring Physician / Technician	4-14
Phone Number	4-15
Medication	4-15
Comments	4-15
Swedish Patient ID	4-15
ID Required	4-15
Secondary ID	4-16
Secondary ID Required	4-16
Last/First Name Required	4-16
Location Number	4-16
Room	4-16
Order Number	4-16
Prompts	4-16

5

Automatic Mode Recording	5-1
General Information	5-3
Recording	5-5
The Storage Program	5-8
Report Formats	5-10
Detailed Results	5-11
ECG Transmission	5-12
General Considerations	5-12

Batch Transmission	5-12
Transmission Log	5-13
Error Messages	5-13
Transmission to a CardioSys/CardioSoft System via Modem	5-14
Transmitting Data to a MUSE CV System Via Modem	5-16
Modem Setup (for Modem & Other)	5-19
Adjusting Measurement Points/QT Dispersion	5-21
Global Measurement Points	5-21
Local T Offset Measurement Point/QT Dispersion	5-23

6

Manual Mode Recording	6-1
General Information	6-3
Recording	6-4

7

Arrhythmia Mode Recording	7-1
General Information	7-3
Recording	7-5
During the Recording	7-6
Final Report	7-8

8

Stress Tests	8-1
General Information	8-3
Stress Test Sequences	8-6
Ergometers without Digital Communication Interface	8-6
Ergometers with Remote Start Pulse	8-8
Ergometers with Digital Communication Interface	8-9
Treadmill	8-12
The Master's Step Test	8-14
Creating Custom Protocols	8-17
Running a Stress Test	8-18
Ending the Stress Test	8-21
Final Report	8-22

9	Pacemaker Patients / Recording During Defibrillation .	9-1
	Recording ECGs of Pacemaker Patients	9-3
	ECG Recording During Defibrillation	9-4

10	System Setup	10-1
	General Information	10-3
	Automatic Mode	10-4
	Report Sequence	10-4
	Rhythm Leads	10-4
	Gain	10-4
	Report Format	10-4
	Detailed Results (MAC 1200 / 1200 ST Only)	10-4
	Continuous Rhythm	10-5
	Muscle Filter/AC Filter	10-5
	Muscle Filter Frequency	10-5
	Manual Copy To	10-6
	Number of Copies	10-6
	Interpretation	10-6
	Print Interpretation	10-6
	Override Function [no]	10-7
	Manual Mode	10-8
	Report Sequence	10-8
	Gain	10-9
	Speed	10-9
	Muscle Filter/AC Filter	10-9
	Muscle Filter Frequency	10-9
	Anti-Drift System (ADS)	10-10
	Auto Paper Feed	10-10
	Arrhythmia Mode	10-11
	Report Sequence	10-11
	Gain	10-11
	Muscle Filter	10-11
	AC Filter	10-11
	Muscle Filter Frequency	10-12
	Trend Recording	10-12
	Arrhythmia Data	10-12
	Episodes	10-12
	Stress Test Mode	10-13
	Report Sequence	10-13
	Protocol	10-13
	Rhythm Leads	10-18

Gain	10-18
Speed	10-18
In-Test Reports	10-18
Muscle Filter/AC Filter	10-18
Muscle Filter Frequency	10-19
Maximum HR After	10-19
J+x Point Formula	10-19
Calculation (E, J Point)	10-19
Arrhythmia Data	10-19
Final Reports	10-20
System Setup	10-21
Ordering Physician/Referring Physician/Technician	10-21
Institution Name	10-21
Cart Number	10-21
Site Number *	10-21
Location*	10-22
Date/Time	10-22
Lead Fail Beep	10-22
High HR Beep	10-22
Lead Labels	10-22
Pace Enhancement	10-22
Baseline Roll Filter	10-22
Date	10-23
Time	10-23
Units	10-23
Mains	10-23
LCD Light Off After	10-23
Low Battery Beep	10-23
Beep for Master Step	10-23
Default mode	10-24
Language	10-24
Enable Password Protection	10-24
Test Data	10-24
Restore Defaults	10-24
Print Configuration Lists	10-24
Transmission Log	10-25
Check Record Retxn	10-25
Communication	10-26
Baud Rate (PC)	10-26
Protocol	10-26
Modem	10-26
PIN Dialing	10-27
Manual Dialing	10-27
Ergometer/Treadmill	10-28
Patient Data Menu Setup	10-29
Required Data Fields	10-30
Prompts 1 to 4	10-30

Option Code	10-31
ECG Transmission via Modem	10-32
Selecting the Communication Protocol	10-32
Direct ECG Transmission	10-33
Selecting the Communication Protocol	10-33

11	Loading Chart Paper	11-1
	Procedure	11-3
	End-of-Paper Indication	11-5
	Aging Stability	11-6

12	Cleaning, Disinfection and Maintenance	12-1
	Cleaning and Disinfecting the Recorder Housing	12-3
	Cleaning and Disinfecting the Patient Cable	12-3
	Cleaning and Disinfecting the Electrodes	12-3
	Maintenance	12-4
	Checks Before Each Use	12-4
	Technical Inspections	12-4
	Disposal	12-4

13	Troubleshooting	13-1
	Troubleshooting Chart	13-3

14	Technical Specifications	14-1
	Recording	14-3
	Printer Paper	14-3
	Paper Transport	14-3
	Membrane Keypad	14-4
	Display	14-4
	Indicators (LEDs)	14-4
	Lead Selection	14-4
	Automatic Functions	14-4
	Detection of Pacer Pulses	14-5
	Heart Rate Indication	14-5
	Signal Inputs	14-5
	Data Interface	14-6

Transfer of ECGs with the CSI Protocol Between the MAC 1200 and the Following Units	14-6
Receiving Data with the CSI Communication Protocol from the Following Units	14-6
Sending ECGs to the Following Units with the A5 Protocol	14-6
Remote Start (Hardware)	14-7
Signal Transmission	14-8

15	Order Information	15-1
	General Information	15-3
	Options	15-3
	General Accessories	15-3
	Entering Special Characters	A-1
	Special Characters	A-3
	Index	Index-1

For your notes

1 The Basics

For your notes

About This Manual

Manual Purpose

This manual describes the safe and effective operation of the MAC 1200/1200 ST unit.

NOTE

This document describes the functionality of the international (non-U.S.) interface for the MAC 1200/1200 ST unit.

Information in this manual differs from operating information for MAC 1200 units developed for use in the United States. Please refer to PN 2012250-022 for information on using the U.S. interface.

MAC 1200/1200 ST

The MAC 1200/1200 ST is a electrocardiograph with the following performance features.

Electrocardiograph equipped with standard software for the following modes of operation.

- Automatic (acquisition of 12 leads of ECG for a period of 10 seconds)
- Manual (real-time recording of 6 ECG leads)
- Arrhythmia (recording of 6 ECG leads with continuous arrhythmia analysis)

The graphics display shows 3 leads at a time.

Resting ECGs acquired in the automatic operating mode can be transferred BETWEEN the MAC 1200 and a PC and FROM the MAC 1200 to a MUSE CV system via the RS232 interface.

The unit operates on AC line power and can also be powered from a rechargeable battery. The unit can be ordered with an optional integrated suction pump for the electrode application system KISS.

The performance features of the MAC 1200 / 1200 ST can be upgraded with the following optional programs.

- MEAS — measurement of the 10-second resting ECG
- DIAG — interpretation of the 10-second resting ECG
- MEMO — storage of a maximum of 40 10-second resting ECGs
- ERGO — stress test ECG (MAC 1200 ST only)

Both versions of the electrocardiograph have a configuration menu to customize the system setup.

Patient and user data can be entered for reliable and safe archiving of patient records. The patient name is annotated on each printed sheet. All other data are printed on request.

The MAC 1200/1200 ST units are designed to comply with IEC 60601 / EN 60601 requirements. They are protection class I devices/devices with an internal power source. They are classified as MDD class IIa devices. They are designed for continuous operation. The units are not suitable for intracardiac application. The units are not intended for use as vital signs physiological monitors.

CAUTION

PATIENT HAZARD — Medical technical equipment such as the MAC 1200/1200 ST must only be used by qualified and trained personnel.

Intended Audience

This manual is geared for clinical professionals. Clinical professionals are expected to have working knowledge of medical procedures, practices, and terminology as required for monitoring of critically ill patients.

Definitions

The following formats are used in this manual to highlight various web viewer features and functions.

Black text	Indicates keys on the keyboard, text to be entered, or hardware items such as buttons or switches on the equipment.
<i>Italicized text</i>	Indicates software terms that identify menu items, buttons, or options in various windows.
Ctrl+Esc	Indicates a keyboard operation. A (+) sign between the names of two keys indicates that you must press and hold the first key while pressing the second key once. For example, "Press Ctrl+Esc " means to press and hold down the Ctrl key while pressing the Esc key.

- <Space> Indicates you must press the space bar. When instructions are given for typing a precise text string with one or more spaces, the point where the space bar must be pressed is indicated as: <Space>. The purpose of the < > brackets is to ensure you press the space bar when required.
- Enter Indicates you must press the "Enter" or "Return" key on the keyboard. Do not type "enter".

Illustrations and Names

All illustrations in this manual are provided as examples only. They may not necessarily reflect your monitoring setup or data displayed on your monitor.

In this manual, all names appearing in examples and illustrations are fictitious. The use of any real person's name is purely coincidental.

Revision History

This manual has a revision letter, located at the bottom of each page. This revision letter changes whenever the manual is updated. Revision A is the initial release of the document.

Revision	Date	Comments
A	7 March 2003	Initial release of manual, describes version 6.0.
B	15 April 2003	Information regarding UL classification added to manual.
C	21 July 2004	Revised CE compliance information and added information about ending a stress test.

Safety Information

This manual is an integral part of the device. It should always be kept near the device. Close observance of the information given in the manual is a prerequisite for proper device performance and correct operation and ensures patient and operator safety. Please note that information pertinent to several chapters is given only once. Therefore, carefully read the manual once in its entirety.

The symbol  means: Consult accompanying documents. It indicates points which are of particular importance in the operation of the device.

This manual is in conformity with the device specifications and standards on safety of electromedical equipment valid at the time of printing. All rights are reserved for devices, circuits, techniques, software programs, and names appearing in this manual.

On request GE will provide a service manual.

The GE quality management system complies with the standards DIN EN ISO 9001 and EN 46001.

To ensure patient safety, the specified measuring accuracy, and interference-free operation, we recommend to use only original GE components. The user is responsible for application of accessories from other manufacturers.

The warranty does not cover damage resulting from the use of unsuitable accessories and consumables from other manufacturers.

GE is responsible for the effects on safety, reliability, and performance of the device, only if

- assembly operations, extensions, readjustments, modifications, or repairs are carried out by GE or by persons authorized by GE, and
- the device is used in accordance with the instructions given in this operator's manual.

Definitions

The terms danger, warning, and caution are used throughout this manual to point out hazards and to designate a degree or level of seriousness. Familiarize yourself with their definitions and significance.

Hazard is defined as a source of potential injury to a person.

DANGER indicates an imminent hazard which, if not avoided, will result in death or serious injury.

WARNING indicates a potential hazard or unsafe practice which, if not avoided, could result in death or serious injury.

CAUTION indicates a potential hazard or unsafe practice which, if not avoided, could result in minor personal injury or product/property damage.

NOTE provides application tips or other useful information to assure that you get the most from your equipment.

The safety information given in this manual is classified as follows.

DANGER

EXPLOSION HAZARD — The device is not designed for use in areas of medically used rooms where an explosion hazard may occur. An explosion hazard may result from the use of flammable anesthetics, skin cleansing agents and disinfectants.

WARNINGS

SHOCK HAZARD — Strictly observe the following warnings. Failure to do so may endanger the lives of the patient, the user and bystanders.

- ◆ Before using the device, the operator must ascertain that it is in correct working order and operating condition. In particular, all connectors, electrodes as well as sensors and probes must be checked for signs of damage. Damaged parts must be replaced immediately, before use.
 - ◆ When disconnecting the device from the power line, remove the plug from the wall outlet first, before disconnecting the cable from the device. Otherwise there is a risk of coming in contact with line voltage by inadvertently introducing metal parts in the sockets of the power cord.
 - ◆ The mains plug must be connected to an appropriate power supply with a non-fused grounded-to-earth wire. If these requirements cannot be met, operate the device on battery power.
 - ◆ Do not use multiple portable socket outlets (MPSO) to connect the device to the power line.
 - ◆ Devices may be connected to other devices or to parts of systems only when it has been made certain that there is no danger to the patient, the operators, or the environment as a result. In those instances where there is any element of doubt concerning the safety of connected devices, the user must contact the manufacturers concerned or other informed experts as to whether there is any possible danger to the patient, the operator, or the environment as a result of the proposed combination of devices. Standards IEC 60601-1-1/EN60601-1-1 must be complied with in all cases.
 - ◆ All devices of a system must be connected to the same electric circuit. Devices which are not connected to the same circuit must be electrically isolated (isolated RS232 interface).
-
-

WARNINGS

EQUIPMENT FAILURE — Magnetic and electrical fields are capable of interfering with the proper performance of the device. For this reason make sure that all peripheral devices operated in the vicinity of the recorder comply with the relevant EMC requirements. X-ray equipment, MRI devices, radio systems (cellular telephones) etc. are possible sources of interference as they may emit higher levels of electromagnetic radiation. Keep the recorder away from these devices and verify the recorder performance before use.

SUFFOCATION HAZARD — Dispose of the packaging material, observing the applicable waste-control regulations. Keep the packaging material out of children's reach.

CAUTIONS

EQUIPMENT DAMAGE — Devices intended for emergency application must not be exposed to low temperatures during storage and transport to avoid moisture condensation at the application site. Wait until all moisture has vaporized before using the device.

EQUIPMENT DAMAGE — Before connecting the device to the power line, verify that the ratings of your local power line are those indicated on the device nameplate.

Classification

The unit is classified, according to IEC 60601-1, as:

Type of protection against electrical shock	Class I internally powered equipment
Degree of protection against electrical shock	Type CF defibrillation-proof applied part
Degree of protection against harmful ingress of water	Ordinary Equipment (enclosed equipment without protection against ingress of water)
Degree of safety of application in the presence of a flammable anesthetic mixture with air or with oxygen or nitrous oxide	Equipment not suitable for use in the presence of a flammable anesthetic mixture with air or with oxygen or nitrous oxide
Method(s) of sterilization or disinfection recommended by the manufacturer	Not applicable
Mode of operation	Continuous operation

Underwriters Laboratories, Inc.



Medical Equipment
 With respect to electric shock, fire and mechanical hazards
 only in accordance with UL 2601-1, and CAN/CSA C22.2
 NO. 601.1.

Biocompatibility

The parts of the product described in this operator manual, including all accessories, that come in contact with the patient during the intended use, fulfill the biocompatibility requirements of the applicable standards. If you have questions in this matter, please contact GE Medical Systems *Information Technologies* or its representatives.

Literature

Medical Device Directive of August 2, 1994

EN 60601-1: 1990 + A 1: 1993 + A 2: 1995

Medical electrical equipment. General requirements for safety.

EN 60601-1-1: 9/1994 + A1: 12/1995

General requirements for safety. Requirements for the safety of medical electrical systems.

IEC-Publication 513/1994: Fundamental aspects of safety standards for medical equipment.

Service Information

Requirements

Refer equipment servicing to GE Medical Systems *Information Technologies'* authorized service personnel only. Any unauthorized attempt to repair equipment under warranty voids that warranty.

It is the user's responsibility to report the need for service to GE Medical Systems *Information Technologies* or to one of their authorized agents.

Every GE Medical Systems *Information Technologies* device has a unique serial number for identification. The serial number appears on the device label.

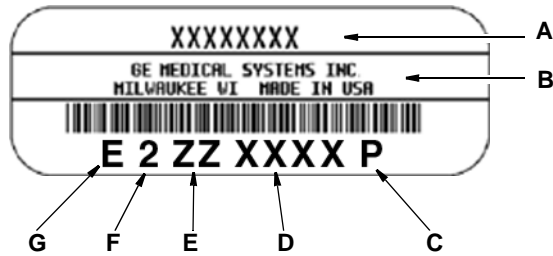

102A

Item	Description
A	name of device
B	manufacturer
C	location code
D	serial number
E	unique product code
F	last digit of year manufactured
G	month manufactured

2 Controls and Indicators

For your notes

General Information

Controls and indicators of the MAC 1200/1200 ST electrocardiograph are shown in this chapter.

MAC 1200 Control Panels

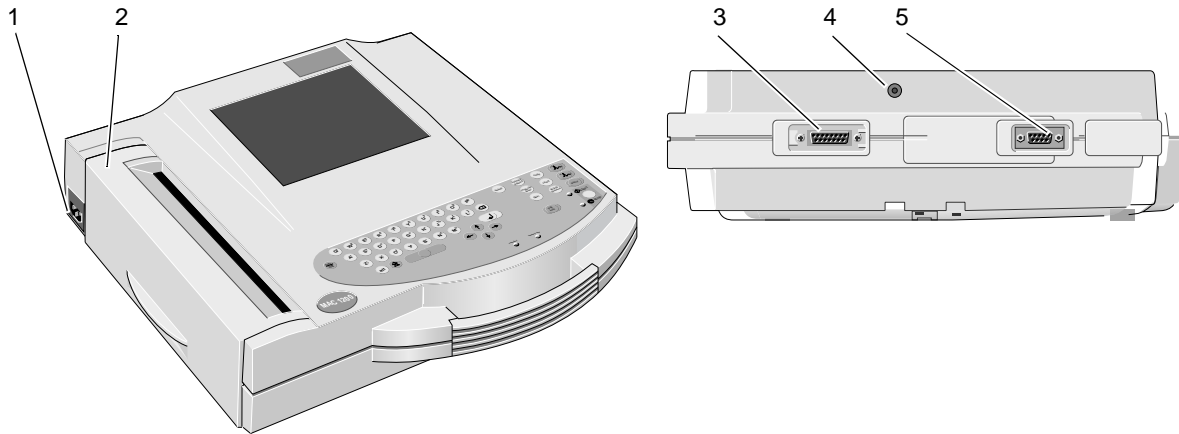

001A

	Description
1	Power input
2	Paper door, windows allows you to check the paper supply
3	Patient cable connector
4	Connection for electrode application system KISS (option)
5	Serial interface (See Chapter 14, "Technical Specifications" for details.)

MAC 1200 Keyboard

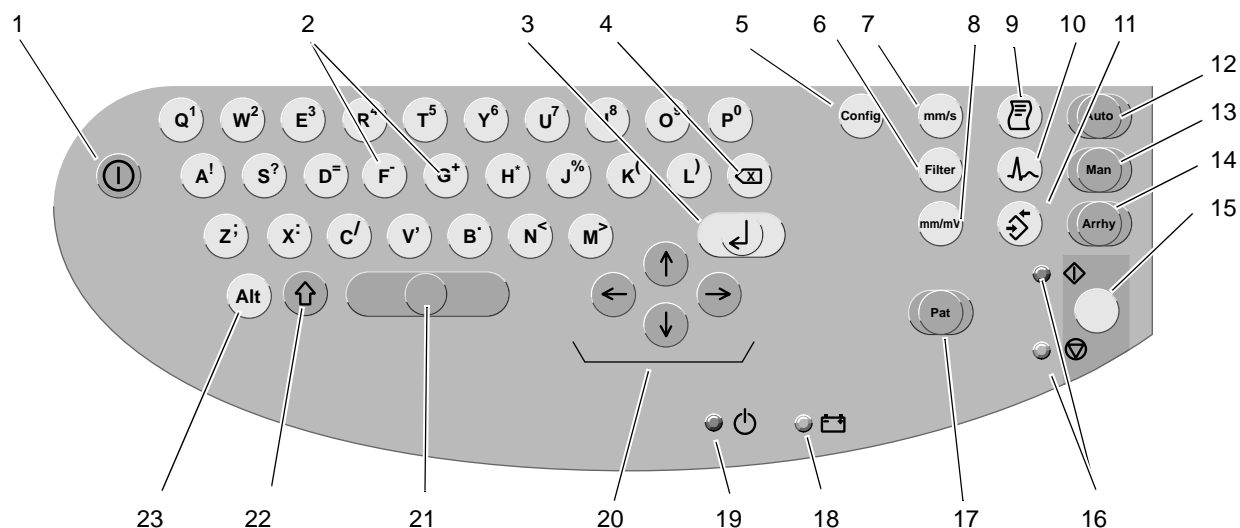

098A

	Description
1	Power switch (ON/OFF)
2	Keys to select a higher or lower HR alarm limit
3	Confirms entered data
4	Correction key (entry of data)
5	Displays the configuration menu
6	Enables/disables the muscle filter (elimination of muscle artifact)
7	Selects the writer speed 25, 50 or 5 mm/s in Manual Mode and the report formats in Automatic Mode
8	Selects the gain (5, 10, 20, 40 mm/mV)
9	Press to print the report or additional copies of the ECG, or to send/receive ECGs
10	Selects the ECG leads displayed and recorded in Manual Mode and displayed Automatic Mode
11	Sends ECG to memory/retrieves ECG from memory
12	Selects the Automatic Mode
13	Selects the Manual Mode
14	Selects the Arrhythmia Mode
15	Starts and stops the recorder, clears the setup menu and terminates patient data entry
16	Indicators: Green: recording in selected mode started; Yellow: recording in selected mode stopped

	Description
17	Enables entry of patient data
18	Indicator lights up when battery needs to be recharged
19	Indicator is illuminated when unit is connected to the power line
20	Cursor control keys
21	Space bar
22	Shift key
23	Press to access special characters



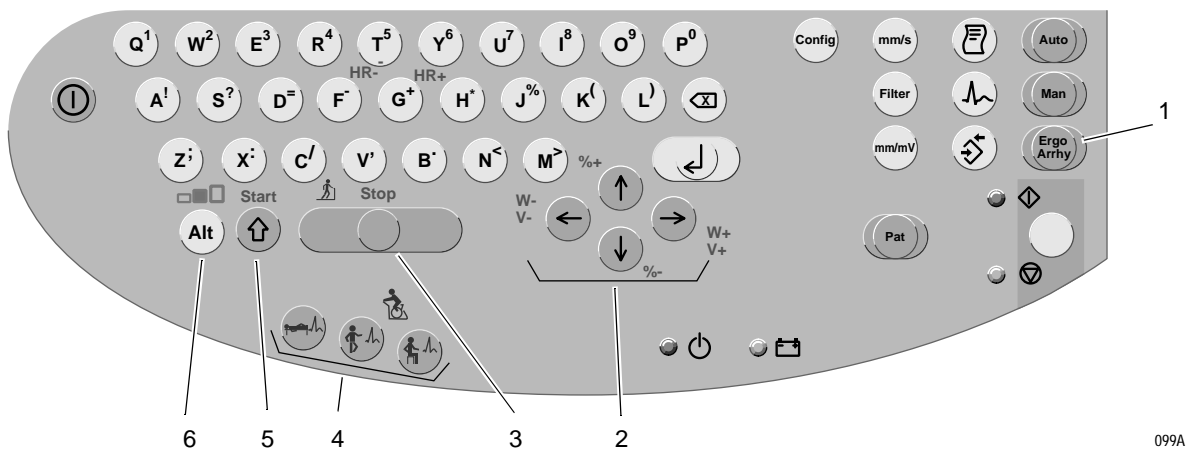













MAC 1200 ST Keyboard



099A

	Description
1	Selects the Stress Test mode and the Arrhythmia mode (press button twice)
2	Increases / reduces load (W), treadmill grade (%), and treadmill speed (V)
3	Stops the treadmill
4	Starts the test phases (pre-test, exercise, recovery)
5	Starts the treadmill
6	Holds the stage

Symbols

	Consult accompanying documents
	Signal input
	Type CF signal input, highly insulated, defibrillation-proof
	Start
	Stop
	Battery
	Saving/retrieving ECGs
	Correction key
	Direction indicator
	Device ON/OFF
	ECG lead selector
	Printout of reports and ECG copies
	Standby
	Stage hold
	Pre-exercise phase
	Exercise phase
	Post-exercise phase

3 Operating and Performance Tests

For your notes

Power Supply

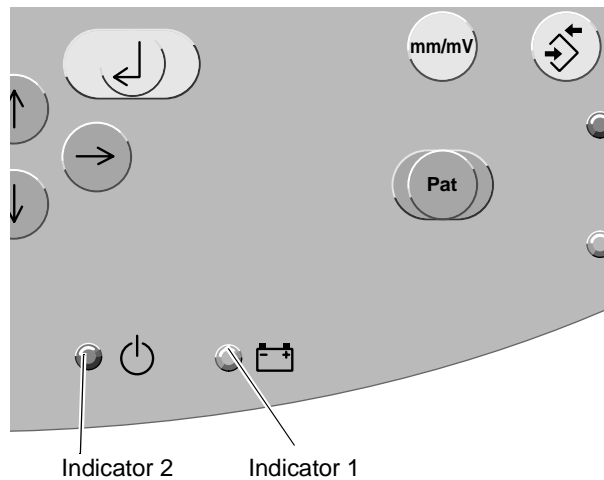

002A

Indicators

The units are powered from the power line or from the rechargeable battery.

The battery charges automatically when the unit is connected to the power line and the green indicator 2 is illuminated as shown above. It is not necessary to switch on the device for charging. To ensure that the battery is always fully charged, leave the electrocardiograph connected to the power line whenever possible. The battery regains its full capacity after being connected to the power line for four hours.

Indicator 1 is illuminated when the battery needs to be charged. The unit can also be set up to emit an additional audio signal when the battery requires charging.

With a full battery, about 50 ECGs (1 page each) can be recorded in the Automatic mode. When its capacity drops to about 25 recordings, the battery is used up and must be replaced by a service specialist.

NOTE

To prolong the battery life, fully discharge the battery at least once per month (by operating the electrocardiograph on battery power).

NOTE

In standby mode, a fully charged battery is drained within approximately 4 hours. Therefore, when operating the device on battery power, be sure to turn it off when it is not in use.

Installation and Mains Connection

The figure below shows a practical arrangement of patient and recorder. For interference-free operation, it is important that the patient cable and the power cord do not run parallel.

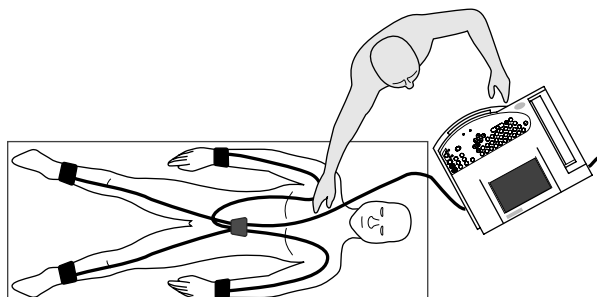

003A

Arranging the Electrocardiograph and the Examination Couch

- Use the power cord to connect the device to the power line (see figure below). Use only the original power cord or an equivalent cable.

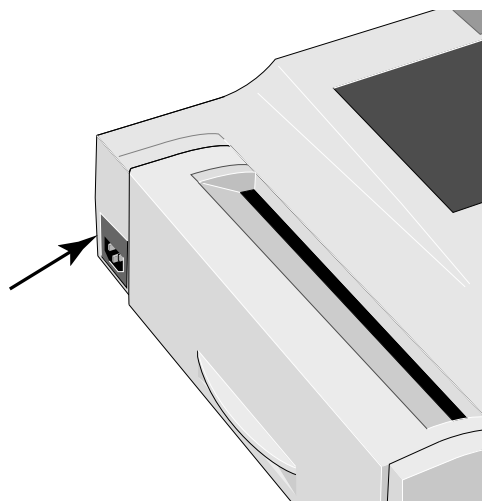

004A

AC Power Input

- Indicator  2 will illuminate.
- Check the paper supply (the window in the paper door allows you to look inside the paper compartment). Refer to Chapter 10, “System Setup” for instructions on inserting a new paper pad.

Performance Check

Press the power button to switch the device on.

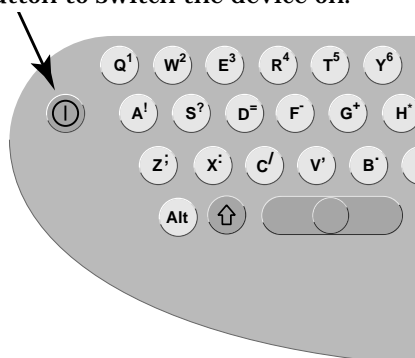

005A

Power Button

The amber indicator will illuminate.

After power-up, the electrocardiograph runs an automatic self-test. The display indicates the memories currently being tested. The self-test takes about 15 to 20 seconds. When no problem is detected, the device defaults to the Automatic mode. If a malfunction is identified, the display will show an error message *Error...* In this situation, notify service to check and repair the device.

The self-test can be skipped with the  button. In this case, the device immediately activates the default mode configured in the Setup menu.

NOTE

The backlighting of the display switches off automatically when no key is activated for 20 minutes (adjustable). The illumination is turned on again by activation of any key.

Run the full self-test at least once a day to ensure that the device is functioning properly.

Press and hold the power button for several seconds to turn the device off.

Contrast Adjustment

Simultaneously press  and the appropriate cursor key:

more contrast ,

less contrast .

System Setup

The table below shows the system setup parameters that can be modified, as well as the the factory defaults. Refer to Chapter 10, “System Setup” section for details.

Table 1. System Setup Menu		
Parameter	Factory Default	Options
Ordering Physician	none	selection from a list of 10 names
Referring Physician	none	selection from a list of 10 names
Technician	none	selection from a list of 10 names
Institution Name	empty text box	text box for 40 characters
Cart #	1	1 ... 9999
Site # ¹	1	1 ... 255
Location #		1 ... 600
Ease of Clock Setting	No	Yes
Date (dd.mm.yyyy)	current date	
Time (hh:mm)	current time	
Lead fail beep	No	Yes
High HR beep	No	Yes
Lead Labels	IEC	AAMI
Pace Enhancement	Yes	No
Baseline roll filter	0.08 Hz	0.04 Hz, 0.16 Hz
Date	dd.mm.yyyy	mm/dd/yyyy
Time	24	12
Units	cm, kg	in, lb
Mains	50 Hz	60 Hz
LCD light off after	20 min	1 ... 99 min
Low battery beep	0 (Off)	5 s to 60 s (5 s = beep at 5 second interval)
Beep f. Master Step ²	No	Yes
Default Mode	Automatic	Manual, Arrhythmia (MAC 1200 only), Stress Test (MAC 1200 ST with option)
Language	German	all available languages
Enable password	No	Yes
Test DATA	No	Yes
Restore defaults	No	Yes
Print Configuration Lists	No	Yes

Print ECG Tx.log	No	Yes
Check Record Retxn	No	Yes

1. only for CSI communication protocol
2. with MAC 1200 ST only if the selected exercise device is the MASTER STEP

Connecting Peripheral Equipment

WARNING

SHOCK HAZARD — Strictly observe the following warnings. Failure to do so may endanger the lives of the patient, the user and bystanders.

- ◆ Connecting peripheral devices to the RS232 interface of the electrocardiograph creates a medical system. This system must meet the requirements of IEC 60601-1-1.
- ◆ Use only the original GEMS IT connection cables.
- ◆ All non-medical devices of a system must be connected to the same electric circuit. Devices which are not connected to the same circuit must be electrically isolated (use isolated RS232 interface as per IEC 60601-1).
- ◆ A PC connected to the electrocardiograph should meet the requirements of EN 60601. If it doesn't, it must be set up outside the patient environment. If the PC fulfills the requirements of EN 60950, it must be set up within the medically used area, but outside the patient environment.
- ◆ Do NOT connect PCs to the electrocardiograph that fulfill neither EN 60601 nor EN 60950.
- ◆ Modems connected to the electrocardiograph must meet the requirements of EN 60950 or UL1950 (all modems recommended by GEMS IT meet these requirements). The specific regulations valid in your country must also be observed.

The modem must be set up within the medically used area, but outside the patient environment.

The electrocardiograph can be directly connected via the serial interface to a PC (CardioSoft), to the CardioSys system, or to a MUSE CV system.

Resting ECGs acquired in the Automatic mode, and the corresponding data, can then be transmitted to these peripheral devices. See Chapter 5, "ECG Transmission" section for details.

The table below shows the factory defaults and all possible adjustments.

For instructions on changing the default setup, see Chapter 10, "Communication" section for details.

Table 2. Modem Configuration Menu		
Parameter	Factory Default	Options
Choices for <i>Modem</i> → <i>Other</i>		
	No	other MultiTech 19.2 MultiTech 56k Elsa 14.4 Elsa 28.8 Elsa 33.6 Elsa 56k
Choices for <i>Modem</i> → <i>other</i>		
Phone Number Initial. modem dial string hang-up	AT&FM1X3S 0=1V0 ATDT +++ATH	
Choices for <i>Modem</i> → <i>MultiTech, Elsa</i>		
Dial mode Phone Number Outside line	Tone	Pulse 0 to 9 (20 digits) 0 to 9 (20 digits)

4 Preparing for ECG Recording

For your notes

Connecting the Patient Cable

WARNING

SHOCK HAZARD — Strictly observe the following warnings. Failure to do so may endanger the lives of the patient, the user and bystanders.

- ◆ For reasons of patient safety, use only the original GE Medical Systems *Information Technologies* patient cables. Before connecting the cable to the device, check it for signs of mechanical damage. Do not use a damaged cable.
 - ◆ Ensure that conductive parts (such as the patient, connectors, electrodes, transducers) that are connected to the isolated patient signal input do not come into contact with other grounded, conductive parts. This would bridge the patient's isolation and cancel the protection provided by the isolated input. The neutral electrode, in particular, must not come into contact with ground.
-
-

If your electrocardiograph is equipped with an integrated suction pump connector, you can connect the electrode application system KISS instead of the standard patient cable.

Use the 10-lead patient cable for acquisition of the standard ECG leads (Einthoven, Goldberger, Wilson). The 12-lead patient cable is required when you intend to record the Nehb leads also.

- Connect the patient cable to ECG signal input.
- When using the electrode application system, connect it to the suction pump.

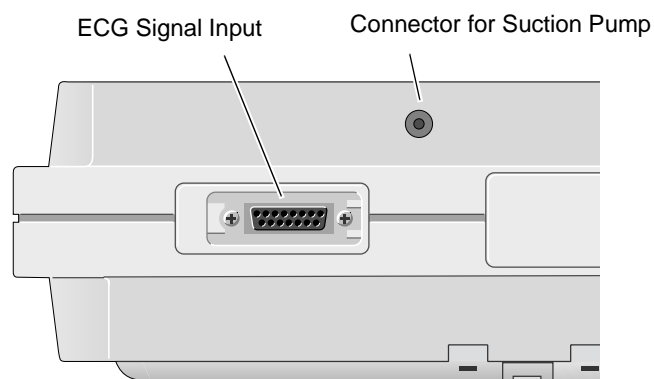

006A

Electrode Application

CAUTION

PATIENT HAZARD, Delayed ECG Display — Use only silver-silver chloride electrodes when recording the ECG of a patient who may have to be defibrillated. (Refer to Chapter 9, “ECG Recording During Defibrillation” section for details.)

Careful application of electrodes is the key to an interference-free ECG.

For quick, reliable and trouble-free application of electrodes, we recommend using our electrode application system KISS.

Otherwise, use the plate electrodes on the limbs and the suction electrodes on the thorax.

Applying Plate Electrodes (Limbs)

Plate electrodes are applied by means of a rubber strap, and electrode paper is the recommended contact medium.

- Moisten the electrode paper with tap water and place it between skin and electrode.
- Secure the electrode with the rubber strap (see figure below), but do not hinder blood circulation.

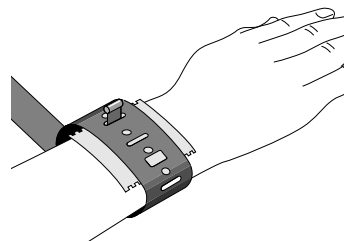

007A

Applying the Plate Electrodes

Applying Suction Electrodes (Chest)

- Shave application points, if necessary.
- Moisten the electrode paper with tap water and place it between skin and electrode. Electrode cream or gel can be used instead of paper. On hairy chests, the cream or gel improves adhesion of the electrodes.

Electrode Placement for Standard Leads (I, II, III, aVR, aVL, aVF, V1...V6)

For acquisition of the standard ECG leads, four electrodes must be applied on the limbs and six on the chest. The limb electrodes should be placed above the wrists and ankles. The figure below shows the chest electrode application points.

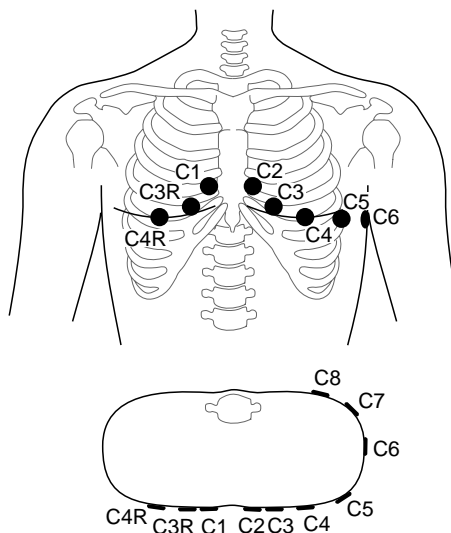

008A

Chest Electrode Placement

	Description
C1	4th intercostal space at the right border of the sternum
C2	4th intercostal space at the left border of the sternum
C3	On the 5th rib, midway between locations C2 and C4
C4	At the mid-clavicular line in the 5th intercostal space
C5	At the anterior auxiliary line on the same horizontal level as C4 and C6
C6	At the mid-auxiliary line on the same horizontal level as C4
C7*	At the left posterior auxiliary line in the 5th intercostal space
C8*	At the left scapular line in the 5th intercostal space
C3R*	Opposite C3, on the right side of the chest
C4R*	Opposite C4, on the right side of the chest

* additional standard leads

Connect the 10-lead patient cable as shown below.

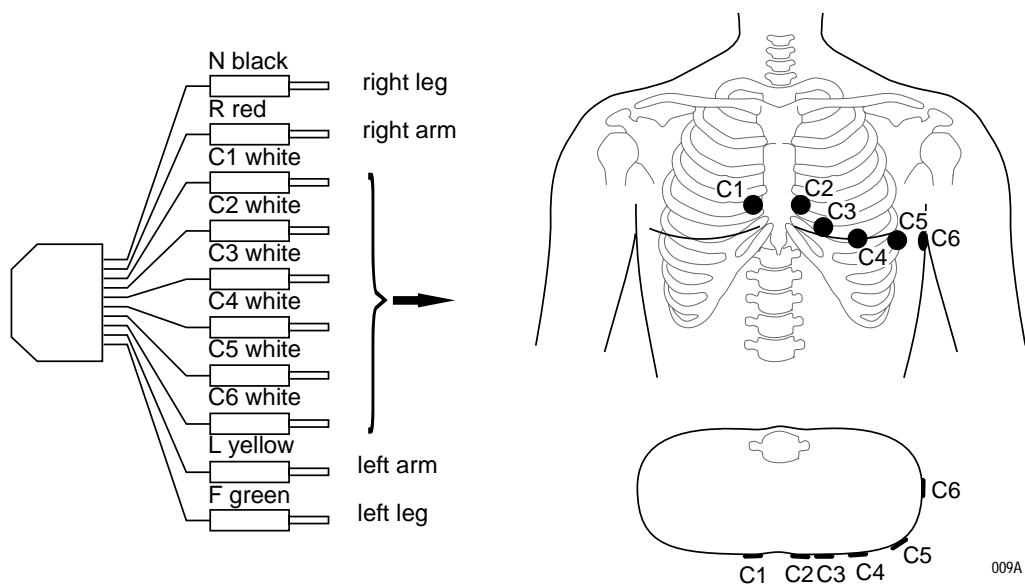

Connecting the Patient Cable (10-Lead Cable, Standard ECG Leads)

Arrange the leadwires and patient cable as shown below.

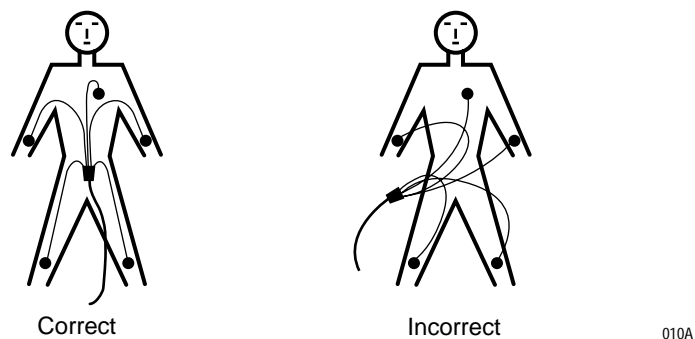

Arranging the Patient Cable

Electrode Placement for Nehb Leads

The figure below shows the electrode sites for acquisition of the Nehb leads. Connect the 12-lead patient cable as shown in the figure on the next page (Nap is the same as C4).

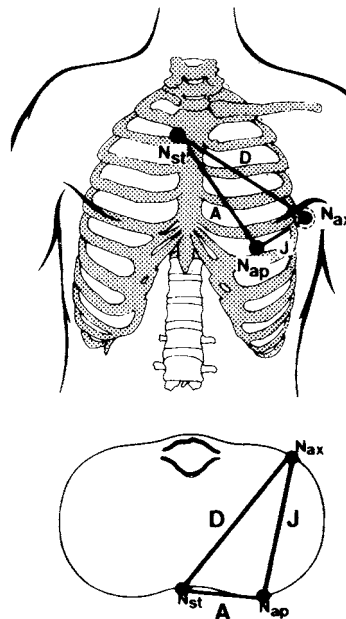

011A

Electrode Placement for Nehb Leads

- Nst 4th intercostal space at the right border of the sternum
- Nax At the posterior auxiliary line in the 5th intercostal space (identical with C7)
- Nap At the mid-clavicular line (identical with C4) in the 5th intercostal space

As an alternative it is also possible to record the Nehb leads with the 10-lead patient cable (only in Manual Mode).

- To do so, connect as follows.
 - R to Nst
 - L to Nax (C7)
 - F to Nap (C4)
- Select *SEQ. No. 4* (Chapter 10, “Manual Mode” section) and change the lead labels as follows.
 - I to D
 - II to A
 - III to J

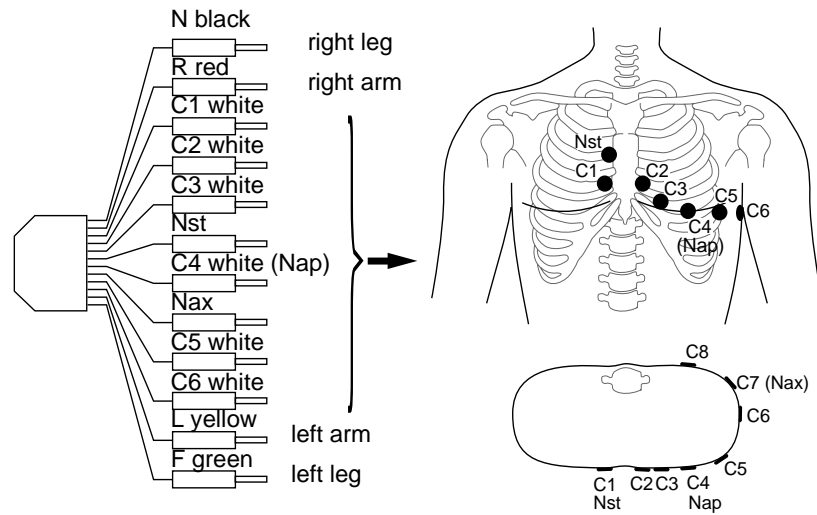

012A

Connecting the Patient Cable (12-Lead Cable, NEHB Leads)

Artifact Due to Poor Electrode Application

The electrocardiograph is equipped with state-of-the-art electronic utilities that ensure artifact-free recordings. Among these are the automatic baseline adjustment and the anti-drift system (cubic spline) (ADS).

At the beginning of the recording the automatic baseline adjustment algorithm verifies the incoming signal and adjusts the baseline position accordingly.

During the recording, the anti-drift system (cubic spline) continuously checks the baseline position and returns it to the normal level, if required (see Sample Recording figure).

For the Manual Mode, the anti-drift system (cubic spline) can be enabled and disabled from the setup menu, in the Automatic and Arrhythmia Modes, it is always enabled.

When electrodes are not properly applied, these measures may not fully compensate for artifact. High polarization voltages induced by electrodes applied without conductive gel may cause the amplifier to overrange, so that a straight line will be recorded instead of the ECG (see figure). In this situation the device will automatically block and return the baseline to its normal position. A baseline is then recorded for approximately 1 second. It is possible to block the amplifiers manually by disconnecting the R electrode.

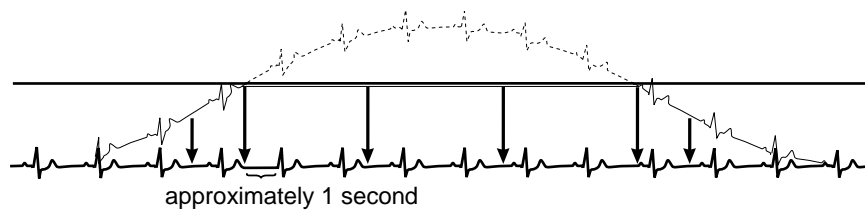

013A

Sample Recording











On the display this condition is indicated by **** instead of the electrode label).

Remedy

- Apply the electrodes according to instructions.
- Do not apply the electrodes on top of clothing.
- Use a contact agent (e.g. moistened electrode paper, electrode cream, spray, etc.).
- Wait approximately 10 seconds before initiating a recording. After the 10-second period, the automatic functions are enabled and the polarization voltages have stabilized, provided the electrodes are properly applied. In case of improper electrode application, an error message will appear on the display (R, L, F, N, C1 to C6, NA, NT, NX).
- If required, the ADS (cubic spline) and the filters (20/40 Hz, 50 Hz) can be disabled to verify the “raw” ECG signal.

Entering Patient Data

It is possible to enter patient data and have them annotated on the recording for easy archiving of patient records.

- Press  to enter the patient data mode.
 - ◆ The recorder displays the menu items in a defined order. In the configuration menu (Chapter 10, “Patient Data Menu Setup” section for details) you determine the items to be included in the menu (In the table on the next page, the items that appear in the patient data menu in the default configuration are marked as *Yes* in the *Menu item displayed* column, the other menu items are marked as *No*).
 - ◆ To skip a menu item, press  or the cursor key  or .
 - ◆ It is not possible to write capital and small letters (do not press the Shift key). For entry of numbers (e.g. date of birth), it is not necessary to press the Shift key.
 - ◆ For fields that allow alphanumeric entries the NumLock function can be enabled with  (the symbol  appears in the upper right corner of the display).
 - ◆ All entries must be confirmed with .
 - ◆ Press  or   to exit the patient data mode.

NOTE

Please refer to the Appendix for instructions on entering special characters.

The table below shows the menu items in the correct order. On the display, selected options are shown in brackets. After the table each Parameter is explained in detail.

Parameter	Factory Default		Options
	Adjusted	Menu Item Displayed	
New Patient	No	Yes	Yes
Last name		Yes	
First name		Yes	
Date of Birth	00.00.0000(dd.mm.yyyy)	Yes	
Patient ID		Yes	
Chest pain ¹	Unknown	Yes	Not Present, Secondary Complaint, Chief Complaint
Pacemaker	No	Yes	Yes
Gender	-	Yes	female, male
Height		Yes	
Weight		Yes	
Race	unknown	Yes	other
Systolic BP	0 mmHg	Yes	
Diastolic BP	0 mmHg	Yes	
Ordering Physician		Yes	selection from a list of 10 names
Referring Physician		Yes	selection from a list of 10 names
Technician		Yes	selection from a list of 10 names
Phone No.	--	Yes	
Medication		Yes	
1.	unknown	Yes	other
2.	unknown	Yes	other
Comments		Yes	
Swedish Patient ID		No	
ID Required		No	
Patient ID Length		Yes	3 to 16 characters; default is 9 characters
Secondary ID		No	
Secondary ID Required		No	
Last Name Required		No	
First Name Required		No	
Location #		No	1 ... 600
Room		No	
Order number		No	

Parameter	Factory Default		Options
	Adjusted	Menu Item Displayed	
Prompt 1		No	
Prompt 2		No	
Prompt 3		No	
Prompt 4		No	

1. with 12SL program only

New Patient

Yes: existing patient data are deleted.

No: entered data can be edited.

Last Name, First Name

18 characters each

Date of Birth

You do not need to enter separators between date, month, and year fields.

The  button has the function of the Shift-Lock key when entering data in alphanumeric text boxes. This function allows you to enter the characters shown in the upper part of the keys, without pressing the Shift key. The ▼ symbol appears in the display to indicate the Shift-Lock status.

Patient ID

This field accepts 3 to 16 characters. The exact length is determined in the patient data setup menu.

NOTE

When entering a patient ID which consists of numerals only, the blanks preceding the number are replaced with 0. Example: If a 6-digit text box is configured and you enter the patient ID 123, the final ID number will read "000123". The default value for this field is 9 characters.

Chest Pain

NOTE

The chest pain option is for use with 12SL program only.

The entry for this menu item is passed on to the 12SL program which considers it in the test interpretation. If you choose one of the options and, additionally, enter the patient's gender and date of birth, the program will determine a percentage value indicating the probability of acute ischemia. This value along with a reason for this conclusion will appear in the interpretation.

Pacemaker

Influences the identification of pacer pulses in Arrhythmia Mode. Enable the function *Yes* when recording the ECG of a pacemaker patient. The recording will then be annotated with the message *Pacemaker Patient*.

Gender/Race

These parameters influence the ECG. If you do not intend to enter all patient data, select the neutral entries “-” and *unknown*.

Height/Weight

Enter the patient's height (cm) and weight (kg). The weight can be entered with one decimal place.

Systolic BP/Diastolic BP

Enter the blood pressure readings in mmHg.

Ordering Physician / Referring Physician / Technician

When you choose *Yes* for *New patient*, the default names entered in the System Setup will appear here. When you choose *other*, you can pick a name from the list. It is also possible to choose *none*. You can press





to quit the list. The *Referring Physician* is only relevant if you send ECGs to the MUSE CV system. This name will not be annotated on the ECG recording.

Phone Number

Enter the patient's telephone number.

Medication

When you choose *others*, you will see the following list (scroll through the list with  and confirm with ):

- no
- unknown
- Digitalis
- Diuretics
- Antidepress.
- Steroids
- Beta-blockers II
- Beta-blockers III
- Antiarrhythmics Ia
- Antiarrhythmics Ib
- Antiarrhythmics Ic
- Antiarrhythmics III
- Ca antagonist, verapamil type
- Ca antagonist, nifedipine type
- Nitrates
- ACE
- Alpha-blockers
- Cytostatics

Comments

4 lines of 30 characters each

Swedish Patient ID

Default value is *No*

ID Required

Default value is *No*

Secondary ID

This field accepts 3 to 16 characters. The exact length is determined in the patient data setup menu.

Secondary ID Required

Yes: patient secondary ID required.
No: patient secondary ID not required.

Last/First Name Required

Yes: patient last or first name required.
No: patient last or first name not required.

Location Number

ID number for the location (3-place). When you select *Yes* for *New patient*, the default value from the *System Setup* will automatically be adopted, but you can overwrite this number.

Room

5 digits

Order Number

9 digits for entry of the ECG order number.



Prompts

Answer the prompts entered in the patient data setup menu. (See Chapter 10, "Patient Data Menu Setup" section for details).

5 Automatic Mode Recording

For your notes

General Information

In Automatic mode, 12 leads of ECG are acquired simultaneously for a period of 10 seconds. When initiated with  , the recording proceeds automatically.

Depending on the implemented software options, the ECG is:

- only printed out (MAC 1200/1200 ST without options MEAS, DIAG),
- measured and printed out with the measurement results (MAC 1200/1200 ST with option MEAS), and
- measured, interpreted (analyzed) and printed out with the interpretative statements (MAC 1200/1200 ST with option DIAG).

NOTE

The program will only interpret the standard and Cabrera lead sequences. The NEHB leads will only be measured.

Units equipped with the optional memory function MEMO (MAC 1200/1200 ST only) can save up to 40 resting ECG. These ECGs can be printed or sent to CardioSys/CardioSoft (A5 protocol) or to the MUSE CV system (CSI protocol) (see “The Storage Program” on page 5-8).

The unit offers different report formats for printout of the ECG. With the system defaults, all 12 leads including the measurement and analysis results will be documented on a single sheet. (See “Report Formats” on page 5-10.)

Some of the system settings can be customized. They are identified with “configurable.”

The following information refers to a unit with the system defaults. For instructions on changing the default setup, see Chapter 10, "Automatic Mode" .

Parameter	Factory Default	Options
Report Sequence	STANDARD	CABRERA, NEHB
Rhythm Leads	II, V1, V5, V2, V3, V4	all leads
Gain	10 mm/mV	"*auto", 5, 20, 40 mm/mV
Report Format	12_FS	12_F1, 12_F2, 6_F1, 6_F2, 6_FS, 6_F2_25, 3_F1, H1, H2, A1, 4x2.5R3, 1x10R3, MUSE1
Detailed Results	No	Yes
Cont. Rhythm	Yes	No
Muscle Filter	No	Yes
Muscle Filter Frequency	40 Hz	20 Hz
AC Filter	Yes	No
Manual copy to	EKG	HOST
Number of copies	1	0...9
Delete ECG after Transmission	No	Yes
Autosave ECG	No	Yes
Interpretation	Yes	No
Print Interpretation	Yes	No
Override Function	No	Yes

Recording

NOTE

When an electrode is off the patient the unit will not start in Automatic mode (if the *Override function* is disabled, see Chapter 10, “Automatic Mode”).

When the unit is powered up, it defaults to the Automatic mode (this default setting can be modified).





1. Before recording the ECG, patient data can be entered (). It is recommended that you enter the patient's name so it appears on every report.
2. After applying the electrodes, wait about 10 seconds for the signal to stabilize (stabilization of polarization voltages, see Chapter 4, “Artifact Due to Poor Electrode Application”). If you initiate a recording with   immediately after selecting the Automatic mode, the message *Collecting data* displays, and you will need to wait for 10 to 12 seconds.
3. Before initiating a recording, check the display for error messages. Check all electrodes; if the message persists, there must be a break in the patient cable. Replace the cable with a new one.



Table 2. Messages Indicating Disconnected Electrodes

Symbol	Meaning	Symbol	Meaning
R	Right arm electrode disconnected	*C4*	Chest electrode C4 disconnected
L	Left arm electrode disconnected	*C5*	Chest electrode C5 disconnected
F	Left leg electrode disconnected	*C6*	Chest electrode C6 disconnected
C1	Chest electrode C1 disconnected	*NA*	NEHB electrode Nap disconnected
C2	Chest electrode C2 disconnected	*NT*	NEHB electrode Nst disconnected
C3	Chest electrode C3 disconnected	*NX*	NEHB electrode Nax disconnected

4. Initiate a recording with  . The MAC 1200/1200 ST acquires all 12 leads simultaneously for 10 seconds, and then generates a printout.

NOTE



The device can be set up to allow a recording only when specific patient information has been entered (last name, first name, ID, Secondary ID, Chapter 10, “Patient Data Menu Setup”).

When you initiate a recording with  , the unit prints the most recent 10 seconds of ECG data and analyzes it. Therefore, wait until the patient has been lying relaxed and motionless for about 10 seconds before starting the recording.

NOTE

Filters may suppress diagnostically relevant portions of the signal, because they limit the transmission range. Therefore, only enable filters if necessary.

With the system defaults unchanged, the unit will activate the following functions and settings after power-up (system defaults which can be changed are indicated with “configurable”).

- Automatic mode (configurable)
- Standard report sequence (lead to channel correspondence): I, II, III, aVR, aVL, aVF, V1, V2, V3, V4, V5, V6, also available: CABRERA, NEHB
- Rhythm lead *
- Gain of 10 mm/mV (configurable) (calibration pulse at the beginning of the recording)
- Muscle filter is disabled () (configurable)
- AC line filter is enabled (configurable)
- ADS (anti-drift system) is always enabled
- Report format is *12_FS*, i.e. 12 leads and all data are printed on one page (configurable)
- Interpretation is printed (configurable)
- *Detailed results* page (including the median complexes and the measurement results) is not printed (configurable) (MAC 1200 only)
- Pressing  will produce one copy of the printed ECG (configurable)
- *Override* function is disabled (configurable)

* The selected report format determines the number of displayed rhythm leads (see “Report Formats” on page 5-10). The default report format is the *12_FS* format (without rhythm lead). With the factory default settings, the following rhythm leads are recorded in the different report formats.

- Report formats with 1 rhythm lead: II
- Report formats with 3 rhythm leads: II, V1, V5
- Report formats with 6 rhythm leads: II, V1, V5, V2, V3, V4
- (see Table 1, “Setup Menu for the Automatic Mode,” on page 5-4)



- MAC 1200 with the MEMO (memory) option
 - ◆ ECGs are not automatically stored (configurable)
 - ◆ ECGs that were successfully transmitted to a host system are not automatically removed from memory (configurable)
- QTC is calculated with the Bazett formula (only MAC 1200 with option MEAS (measurement) or DIAG (measurement + interpretation)).

The locations of all relevant device settings are shown below:

Operating mode	Muscle filter ¹	AC line filter ¹	Anti-drift system ¹	“Patient Name”
Report function ²	Gain		Report sequence	
<p>Three leads display here</p>				
Failure message ³			Heart rate	



1. if enabled
2. or *REC OFF* when the recording function is disabled
3. if any

The display shows three leads at a time. With  you can display all leads of the report sequence in groups of three.

- The recording can be stopped with  .
- For a description of the different reports, see “Report Formats” on page 5-10.

The Storage Program

With MAC 1200 units equipped with the optional storage program MEMO the ECG including patient, measurement and analysis data can be saved with the  button after ECG acquisition. A message informs the user that ECGs are being saved and indicates the number of stored ECGs.

To retrieve an ECG from memory, simultaneously press  and .

NOTE





With a fully charged battery and the unit turned off, ECGs will remain stored for approximately 4 weeks.

The function keys appear at the top of the menu:

- *Print* (prints the selected ECG)
- *Send* (see “ECG Transmission” on page 5-12)
- Send all unsent records (see “Batch Transmission” on page 5-12)
- *Delete* (deletes the selected ECG)
- *Change* (enables modification of the patient data)

When you view a saved ECG, the *Print* function is selected. The list on the next page shows all patients for whom ECG are stored.



To perform an action with one or more ECGs, you must first select the ECG(s). Follow these steps:



1. Move the cursor down with . When the cursor reaches the *Print directory*, it moves on to the patient list. In the list, the bar cursor changes to a line cursor.
2. To select multiple ECGs, select them with  , while holding  down. Selected ECGs are marked with a black bar in the margin of the display. Deselect the ECGs with the same key combination.

NOTE

Due to the limited size of the display, you cannot view the entire list at a time. These are the columns that follow to the right of the patient name:

- ◆ Date and time of the ECG recording
- ◆ S (indicates that the ECG has been sent to another system)
- ◆ Patient ID
- ◆ Comments

To display the remaining columns, you can continuously scroll the display with  or you can shift the list by the display's width with  and .



3. When you have selected all ECGs to view, press the  key to return to the function keys.
4. Use the cursor to select the function you need. Initiate it with .

Other Considerations

With the *Print directory* command, you can print a list of all stored ECGs. The printout includes all columns, except the *Comments* column.



If you try to save an ECG when the memory is full, a message informs you of the memory status. When you delete an ECG from memory, the new ECG will automatically be saved.

The unit may be set up to automatically save ECGs (without pressing ) and automatically remove ECGs from memory that were successfully transmitted to the CardioSys, CardioSoft or MUSE systems.

The storage program can be terminated at any time with  .

NOTE

If you plan to print a large number of stored ECGs, connect the unit to the power line or to check that the battery is fully charged.

When you terminate the storage program with  , it is not possible to save the current ECG again.

Report Formats

The length and scope of the reports depends on the implemented software (standard, MEAS (measurement), DIAG (measurement + interpretation)).

The table below shows all of the 14 different report formats available with MAC 1200/1200 ST units.

Format	ECG Traces Length/Leads	Rhythm Lead Length/Leads	Speed	Measurement*	Interpretation*	Pages	Medians
12_FS	10 s / 1x12	no	25 mm/s	no	no	1	no
12_F1	5 s / 1x12	10 s / 1 (V6)	25 mm/s	yes	yes	1	no
12_F2	8 s / 1x12	10 s / 1 (V6)	50 mm/s	yes	yes	2	no
6_F1	2x5 s / 2x6	10 s / 1	25 mm/s	yes	yes	1	no
6_FS	2x5 s / 2x6	10 s / 1	25 mm/s	no	no	1	no
6_F2	2x5 s / 2x6	no	50 mm/s	yes	yes	2	no
6_F2_25	2x10 s / 2x6	no	25 mm/s	yes	yes	2	no
3_F1	4x2.5 s / 4x3	10 s / 1	25 mm/s	yes	yes	1	no
H1**	10 s / 1x6	10 s / 6	12.5 mm/s	yes	yes	1	12
H2	2x5 s / 2x6	no	50 mm/s	yes	yes	2	no
A1**	10 s / 1x6	10 s / 6	12.5 mm/s	yes + matrix	yes	1	12
1x10R3	10 s / 1x3	10 s / 3	25 mm/s	yes	yes	1	no
4x2.5R3	4x2.5 s / 4x3	3x10 s / 3	25 mm/s	yes	yes	1	no
MUSE1	4x2.5 s / 4x3	3x10 s / 2	25 mm/s	yes	yes	1	no

* Measurements and interpretative statements are only available from MAC 1200/1200 ST with the required software options.

** Only possible with option MEAS or DIAG.

NOTE

Heart rate is calculated from all beats of the 10-second ECG.

Printed reports are unconfirmed documents. They must be overread, verified, and signed by a physician for confirmation.

Report formats H1 and A1 are only available with MAC 1200/1200 ST units (option MEAS or DIAG required). In these reports, the rhythm leads are printed with a speed of 12.5 mm/s and the medians with 50 mm/s.

Detailed Results

The MAC 1200/1200 ST (with option MEAS or DIAG) setup menu allows you to choose the *Detailed Results* page. When selected, this page will be appended to the report. It contains patient data, measurement results, interpretative statements (reasons are only annotated if the unit is equipped with the HEART interpretation program), medians and the tabular measurement values.

NOTE

To obtain a printout of the full patient data, select the Manual mode and press .





ECG Transmission

NOTE

Observe the safety information given in Chapter 3, “Connecting Peripheral Equipment”.





Resting ECGs acquired in Automatic mode can be transmitted to CardioSys/CardioSoft or to a MUSE CV system. The units can either communicate via modem or directly via a connection cable (see “Direct Transmission” on page 5-16).

General Considerations

- The status of transmission progress is indicated on the display with message text, e.g., “*Transmitting 1 of 1,*” or “*Transmitting 2 of 6.*”
- With  the transmission can be stopped.
- ECGs that were successfully transmitted are identified with the letter *S* (for “Sent”).
- After the selected ECG records have been successfully transmitted, a confirmation message displays, e.g. “*6 of 6 ECG records successfully transmitted.*”
- All ECG records are time stamped (hours, minutes, and seconds). To view a record’s time stamp, highlight it. Then press  + . Use  to scroll right to see the time stamp.

Batch Transmission

The MAC 1200/1200 ST unit can send all untransmitted records in a batch transmission.

1. Activate the storage program by simultaneously pressing  and . (Press the  button first and hold it depressed.)
2. Select *Send All Unsent Records*. Confirm your choice with .

The message *Initializing transmission* is displayed, and the option to cancel the transmission is provided.

Then it sends batch of ECG records.

3. After the transmission, a message on the display indicates the number of successfully transmitted ECGs. As soon as you acknowledge the message with , the Automatic mode acquisition screen appears.

Transmission Log

The MAC 1200/1200 ST unit can be set up to automatically print a log of the recently completed transmission. See “Transmission Log” on page 10-25 for more information.

If the Transmission log is enabled, after each record is transmitted, the message *Print transmission log?* will display.

Press  to print the log.

The message *Printing Transmission Log* displays as the log is printing.

Error Messages

Transmission error messages are listed below.

<i>ECG transmission error! (A5)/(CSI)</i> (depending on selected protocol)	<i>Check interface!</i>
<i>Dial locked! (temporarily)</i>	<i>No dial tone!</i>
<i>Busy!</i>	<i>No answer!</i>
<i>No carrier!</i>	<i>Check modem configuration!</i>



Transmission to a CardioSys/CardioSoft System via Modem

Depending on the modem model used, the modem **MUST** be connected either with the 9-pole cable 223 378 01 or with the 25-pole cable 223 378 02.

For transmission of the ECG, the unit must be set up as described in Chapter 10, "ECG Transmission via Modem" .



1. After acquiring the ECG, start the transmission with .



The MAC 1200/1200 ST is also capable of transmitting stored ECGs (if memory option MEMO is installed).

Activate the storage program by simultaneously pressing  and . (Press the  button first and hold it depressed.)

2. To select one or more ECGs for transfer, move the cursor down with .

When the cursor reaches *Print directory*, it moves on to the patient list. In the list, the bar cursor changes to a line cursor.

To select multiple ECGs, select them with  , while holding  down. Selected ECGs are marked with a black bar in the margin of the display. Deselect ECGs with the same key combination.

3. When you have selected the ECG(s) to transfer, press . You will be returned to the function key menu.
4. Using the cursor, select the *Send* command. Confirm your choice with .

The transmission menu will be displayed, showing the phone number and the options *Start transmission*, *Modify settings*, and *Cancel*.

5. Check the displayed telephone number and press  to initiate the transfer.

If it is necessary to change the number, press  to display the configuration menu.

NOTE



If the MAC 1200/1200 ST unit is configured for manual dialing, the prompt *Please Dial the number...* will be display. Enter the number to which the ECG is being transmitted. See “Manual Dialing” on page 10-27 for information on configuring the manual dialing option.

6. As soon as you initiate the transmission with , the unit automatically dials the number of the modem at the receiving end and establishes a connection.

The message *Initializing transmission* is displayed, and the option to cancel the transmission is provided. Then it will send the ECG.

7. After the transmission, a message on the display indicates the number of successfully transmitted ECGs. As soon as you acknowledge the message with , the Automatic mode acquisition screen appears.
8. If the ECG could not be transmitted (wrong modem setup, modem off, etc.), the unit will display an error message, such as *Transmission Error! (A5)*.

In this situation you have the following choices:

- ◆ Repeat the transmission with .
- ◆ Change the settings with .
- ◆ Stop the transmission with .

You must select one of these choices to clear the transmission error message from the display.

NOTE

Unsuccessful transmission does not remove/delete the ECG record from the local database.

Transmitting Data to a MUSE CV System Via Modem

NOTE

Pacemaker information, telephone number and comments entered in the patient data are not transmitted to the MUSE CV system.

Before sending data to the MUSE CV system, the MAC 1200/1200 ST automatically logs on to the database. Then the data transfer is initiated. If the transfer is stopped, the MAC 1200/1200 ST takes a few seconds before cancelling the connection because it has to log off the database first. Then the communication link with the receiving modem is interrupted and the standard display reappears.

ECG Record Serial Number

Every ECG record sent to the MUSE CV system contains a unique serial number for tracking purposes. It is made up of the MAC 1200/1200 ST serial number + date + time.

NOTE

The ECG record serial number is printed on the transmission log only (if enabled). It does not appear on the ECG report printed at the MAC 1200/1200 ST unit. See "Transmission Log" on page 10-25 for more information.

Direct Transmission



The unit must be connected to the PC or to the MUSE CV system by means of the connection cable (pn 223 362 03).

For transmission of the ECG, the unit must be set up as described in Chapter 10, "Direct ECG Transmission" section.



1. After acquisition of the ECG, the transmission is started with .



The MAC 1200/1200 ST is also capable of transmitting stored ECGs (if the memory option MEMO is installed).

Activate the storage program by simultaneously pressing  and

. (Press the  button first and hold it depressed.)

2. To select one or more ECGs for transfer, move the cursor down with . When the cursor reaches *Print directory*, it moves on to the patient list. In the list, the bar cursor changes to a line cursor.

To select multiple ECGs, select them with  , while holding down . Selected ECGs are marked with a black bar in the margin of the display. Deselect the ECGs with the same key combination.

3. When you have selected the ECG(s) to transfer, press  and you are back in the function key menu.
4. Using the cursor, select the *Send* command. Confirm your choice with .

The message *Initializing transmission* is displayed, and the option to cancel the transmission is provided.

Then it starts. The message *ECG Transmission (CSI)* is displayed.



5. After the transmission, a message on the display indicates the number of successfully transmitted ECGs. As soon as you acknowledge the message with , the Automatic mode acquisition screen appears.
6. If the ECG could not be transmitted (e.g. wrong baud rate, connection error), the unit will display the error message *Transmission Error! (CSI)*.

The message depends on the selected protocol.

NOTE

Pacemaker information, telephone number and comments entered in the patient data are not transmitted to the MUSE CV system.

In this situation you have the following choices:

- ◆ Repeat the transmission with .
- ◆ Change the settings with .
- ◆ Stop the transmission with .

You must select one of these choices to clear the transmission error message from the display.







NOTE

Unsuccessful transmission does not remove/delete the ECG record from the local database.



Receiving Data with the CSI Communication Protocol

See Chapter 14, “Technical Specifications” for additional information.

Receiving ECGs is only possible with MAC 1200/1200 ST units. The units must be in the Automatic mode.

1. Use the key combination  and  to display the screen for receiving ECGs. The connected modem is automatically initialized. The procedure can be aborted with  .
2. Press  to enable the *receive data* mode. The procedure can be aborted with .
3. When you have enabled the *receive data* mode, the standard screen display of the Automatic mode displays. The message *Auto (REC)* indicates that the unit is ready to receive data.

ECGs can be recorded in the Automatic mode even while the unit is in the *receive data* mode.

4. A message displays on the screen when the unit is receiving data. The reception of data can be aborted with  .
5. The ECG which has just been received is processed for the printout. The report is printed in the selected format. Multiple ECGs are received and printed one after the other.

After printout of the last ECG, the *receive data* mode is automatically disabled. The mode is also disabled when you select another operating mode.

The following information is annotated in the bottom line of each report.

- ◆ Sender
- ◆ Software version and analysis program version used at the sending unit (e.g. ACQ-DEV: V5.1M12i HEART V5.1)

Modem Setup (for Modem → Other)

If you prefer to use another modem than the standard models listed in the *Setup* menu (MultiTech, Elsa), you will have to enter a few parameters required for communication between the MAC 1200/1200 ST and the modem.

For the AT commands which your modem understands, please refer to the modem user instructions. Three command sequences have to be entered, each of which defines a specific modem operating state.

1. The modem is initialized (init string).
2. A communication link is established (dial string).
3. The communication is terminated (hangup string).

These three strings are entered in the modem setup menu. (See Chapter 3, "Connecting Peripheral Equipment")

The example below shows the command strings for the MultiTech ZDX modem.

AT Command for Modem Initialization

Symbol	Description
AT	Prefix that precedes every command line
&F	Fetch factory configuration (loads the factory configuration from ROM into the active configuration memory (RAM))
M1	Speaker is always on
X3	Call progress signal monitoring enabled
S0=1	Auto answer after one ring
V0	Digit result codes selected (0 to 999)
init string:	AT&FM1X3S0=1V0

AT Command for Establishing a Communication Link

The following is an example of a dial string for a modem connected to a branch (PBX system) and dialing a modem via the public telephone network, using the touch tone mode.

Symbol	Description
AT	Prefix that precedes every command line
DT	Touch tone dial mode
xxx	After DT, enter the characters for access to the public telephone network (e.g. 0)
W	W, placed after a number, tells the modem in a PBX system to wait for the dial tone of an outside telephone line
dial string:	ATDTOW

AT Command for Termination of the Communication

The communication is terminated in two steps.

First, the MAC 1200/1200 ST sends an escape command to return from the on-line state to the command state. Then the hangup command follows.

Symbol	Description
+++	Escape command
AT	Prefix that precedes every command line
H	Hangup command
hangup string:	+++ATH

Adjusting Measurement Points/QT Dispersion

This feature is only available with MAC 1200/1200 ST units equipped with the MEAS or DIAG option. The HEART interpretation program is also required.

Global Measurement Points

After acquisition of an ECG in the Automatic mode, the global measurement points for P onset, P offset, QRS onset, QRS offset, and T offset can be adjusted manually.

After acquisition of the ECG, press R_4 to display the screen for verification of the global measurement point markers.

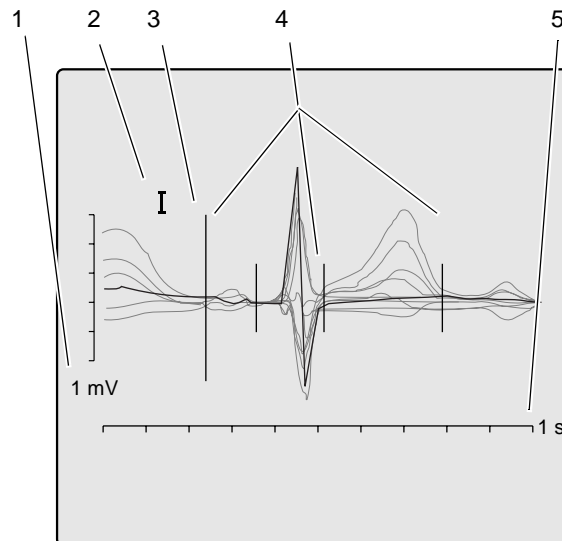

028A

Verification of the Global Measurement Points

	Description
1	Amplitude in [mV]
2	Selected lead
3	Active marker (large)
4	Inactive marker (small)
5	Time in [s]

On this display you will see all 12 ECG leads; the active lead is black and displayed in the foreground, the inactive leads appear dimmed in the background.

The active measurement point marker is large, the four inactive markers are small. Use these keys to adjust the markers.

  moves the active marker right or left

  selects the next or previous marker

 activates the next lead

 changes the gain

 terminates the adjustment, saving the changes

  terminates the adjustment without saving the changes

space bar for the P onset and P offset values, the space bar toggles between *definite value* and *approximate value*.

Local T Offset Measurement Point/QT Dispersion

When you exit the screen for verification of the global measurement points, the screen for verification of the T offset measurement point appears automatically.

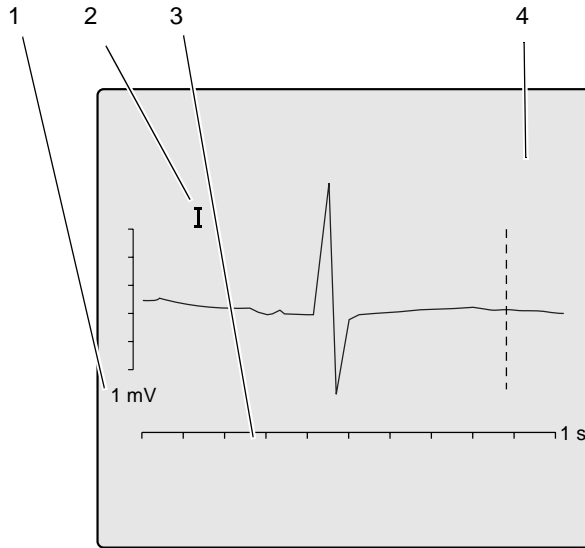



029A

Verification of the T Offset Measurement Point

	Description
1	Amplitude in [mV]
2	Selected lead
3	Time in [s]
4	Active marker

Therefore, this screen always shows only one lead at a time and the T offset point. Changing the local T offset point also affects the QT dispersion value.

Use these keys to adjust the marker.

  moves the marker right or left

 displays the next lead

 changes the gain

 terminates the adjustment, saving the changes

  terminates the adjustment without saving the changes

When you exit the screen, the acquisition screen for the Automatic mode reappears.

The corrected ECG can be printed with the  button.

If the unit is equipped with the MEMO memory option, the corrected data can be saved (or it will be saved automatically when the corresponding function is enabled). If the original ECG had already been saved, the corrected data will overwrite this ECG.

NOTE



Changing the local T offset measurement point does not affect the global T offset point.

6 Manual Mode Recording

For your notes

General Information

In Manual mode, the system acquires six leads of ECG in real time.

Recordings are started and stopped with  . Some of the system settings can be customized. They are identified with “configurable”.

The following information refers to a unit with the system defaults. For instructions on changing the default setup, refer to Chapter 10, “Manual Mode” section for details.



Parameter	Factory Default	Options
Report Sequence	STANDARD	CABRERA, NEHB, SEQ.NO.4
Gain	10 mm/mV	“*auto”, 5, 20, 40 mm/mV
Speed	25 mm/s	5, 50 mm/s
Muscle Filter	No	Yes
Muscle Filter Frequency	40 Hz	20 Hz
AC Filter	Yes	No
Anti-Drift System	No	Yes
Automatic Paper Feed	Yes	No

Recording

NOTE

In Manual mode, messages indicating disconnected electrodes are also annotated on the recording, e.g. *Lead fail C1*.

After switching on the unit, press  to select Manual mode.

- Before recording the ECG, patient data can be entered (). It is recommended that you enter the patient's name to annotate it on every report.
- Before initiating a recording, check the display for error messages (see table below). Check all electrodes; if the message persists, there must be a break in the patient cable. Replace the cable with a new one.
- The recording is started and stopped with  .

R:	Right arm electrode disconnected
L:	Left arm electrode disconnected
F:	Left leg electrode disconnected
C1:	Chest electrode C1 disconnected
C2:	Chest electrode C2 disconnected
C3:	Chest electrode C3 disconnected
C4:	Chest electrode C4 disconnected
C5:	Chest electrode C5 disconnected
C6:	Chest electrode C6 disconnected
NA:	Nehb electrode Nap disconnected
NT:	Nehb electrode Nst disconnected
NX:	Nehb electrode Nax disconnected

NOTE

In Manual mode, report sequences can also be selected with these shortcuts.

 = Standard

 = CABRERA

 = NEHB

 = Seq. 4

With the system defaults, the MAC 1200/1200 ST will activate the following functions and settings.



- The Standard report sequence (lead to channel correspondence): I, II, III, aVR, aVL, aVF, V1, V2, V3, V4, V5, V6 (configurable); also available: CABRERA, NEHB, SEQ. NR. 4 (custom report sequence).
- A gain of 10 mm/mV (configurable) (calibration pulse at the beginning of the recording The unit can be set up to automatically adapt the gain to the ECG signal (see Chapter 10, "Manual Mode").





Also, the gain setting can be changed with  (5, 10, 20 and 40 mm/mV).

NOTE

Please note that filters may suppress diagnostically relevant portions of the signal, because they limit the transmission range. Filters should therefore only be enabled if necessary.

 selects the other 6 leads of the selected report sequence.

  display the other 3 leads of the selected group of 6.

- The writer prints at a speed of 25 mm/s, the speed can be changed with .
- The muscle filter is disabled (configurable).
- The AC line filter is enabled (configurable).
- The anti-drift system (cubic spline) is disabled (configurable).
- Pressing   will not advance the paper to the next fold (Auto Paper Feed) (configurable).
- Pressing  after the ECG recording will print the patient data.

The locations of all relevant device settings are shown below:



Operating mode	Muscle filter ¹	AC line filter ¹	Anti-drift system ¹	"Patient Name"
Report function ²	Gain		Report sequence	
<p>Three leads display here</p>				
Failure message ³			Heart rate	

1. if enabled

2. or *REC OFF* when the recording function is disabled

3. if any

- If you change the writer speed, lead group or any filter settings during a recording, the unit will briefly stop.
- With  you advance to the next group of 6 leads of the selected report sequence.
- When the anti-drift system is enabled, there will be a short delay of 2.2 seconds before the recording starts.

The heart rate limit is automatically calculated from the date of birth (WHO 100% = 220 - age). When the date of birth is not entered, the unit will set the limit at 180 bpm. This value can be changed with  and  (in steps of 5 bpm).

7 Arrhythmia Mode Recording

For your notes

General Information

In Arrhythmia mode, the MAC 1200/1200 ST continuously scans the ECG for arrhythmias. From six simultaneously acquired leads, the MAC 1200/1200 ST automatically selects the two that provide the best signal for analysis.

When the analysis algorithm detects an arrhythmia, the event is recorded with “context” (see figure below). The length of the recording varies with the duration of the event episode. In the setup menu (Chapter 10, “Arrhythmia Mode” section) you determine the conditions for a recording.

- The recorder starts each time it detects a single-beat event.
- The recorder starts each time it detects an event different from the previous event.
- The recorder does not start at all.

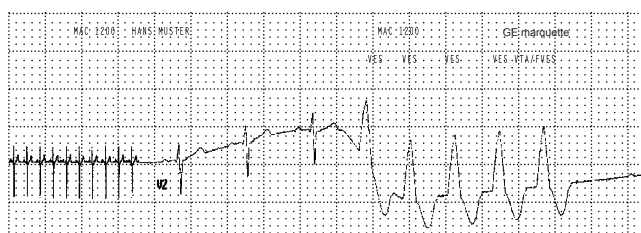

031A

Event Recording

NOTE

After starting the program, press mm/s to select a continuous recording at 5 mm/s (c). If the unit identifies an arrhythmia event, it will automatically switch to the faster paper speed. With the same key mm/s , the trend recording can be stopped. The unit can be set up to automatically start a trend recording when the Arrhythmia mode is initiated.

Some of the system settings can be customized. They are labeled with “configurable”. The following information refers to a unit with the system defaults. For instructions on changing the default setup, refer to Chapter 10, “Arrhythmia Mode” section.

Table 1. Setup Menu for the Arrhythmia Mode		
Parameter	Factory Default	Options
Report Sequence	STD-C	STD_RED STD_LI CABR_LI NEHB HIGH_C
Gain	10 mm/mV	“*auto”, 5, 20, 40 mm/mV
Muscle Filter	No	Yes
Muscle Filter Frequency	40 Hz	20 Hz
AC Filter	Yes	No
Trend Rec.	No	Yes
Arrhy Data	unequal	all, no
Episodes	chron.	prio., ventr., no

Recording

1. After switching on the unit, press  to select the Arrhythmia mode.

When working with the MAC 1200 ST equipped with the Stress Test option ERGO, you must press the button twice.

2. Before recording the ECG, patient data can be entered (). It is recommended that you enter the patient's name to annotate it on every report.

Before initiating a recording, check the display for error messages. Check all electrodes; if the message persists, there must be a break in the patient cable. Replace the cable with a new one.

3. Start and stop the recording with the  key.

Symbol	Definition
R:	Right arm electrode disconnected
L:	Left arm electrode disconnected
F:	Left leg electrode disconnected
C1:	Chest electrode C1 disconnected
C2:	Chest electrode C2 disconnected
C3:	Chest electrode C3 disconnected
C4:	Chest electrode C4 disconnected
C5:	Chest electrode C5 disconnected
C6:	Chest electrode C6 disconnected
NA:	Nehb electrode Nap disconnected
NT:	Nehb electrode Nst disconnected
NX:	Nehb electrode Nax disconnected

During the Recording

When the program starts, the unit records 6 leads of ECG (1 page). During the following learn phase, the analysis algorithm learns the patient's typical QRS complex.

After the learn phase, the recorder prints a report where the QRS complexes acquired in the learn phase are labeled *L* and the complex found to be the patient's typical complex is labeled *QRS_L*.

When the learn phase is complete, the MAC 1200/1200 ST is ready to identify arrhythmias.

NOTE

With  a single-page recording can be initiated after program start.

NOTE

Filters may suppress diagnostically relevant portions of the signal, because they limit the transmission range. Only enable filters if necessary.

With the system defaults, the MAC 1200/1200 ST will activate the following functions and settings.

- STD_C report sequence (lead to channel correspondence) (V1 to V6) (configurable).
- Gain of 10 mm/mV (configurable) (calibration pulse at the beginning of the recording). The unit can be set up to automatically adapt the gain to the ECG signal (*auto).
- Muscle filter is disabled (configurable).
- AC line filter is enabled (configurable).
- Slow trend recording is disabled (configurable).
- Event episodes are recorded at a speed of 25 mm/s.
- Unit documents all events that are different from the previous event (configurable). The unit can be configured to document all events or no events at all.
- In the final report, the event episodes are printed in chronological order.

The locations of all relevant device settings are shown below:

Operating mode	Muscle filter ¹	AC line filter ¹	Anti-drift system ¹	"Patient Name"
Report function ²	Gain		Report sequence	
<p>Three leads display here</p>				
Failure message ³			Heart rate	

1. if enabled
2. or *REC OFF* when the recording function is disabled
3. if any



Refer to Table 3, "Arrhythmia Codes," on page 7-9 for an explanation of the arrhythmia codes annotated on the recording.

The heart rate limit is automatically calculated from the date of birth (WHO 100% = 220 - age). When the date of birth is not entered, the unit will set the limit at 180 bpm. This value can be changed with **F**⁻ and **G**⁺ (in steps of 5 bpm).

NOTE

The letter A on a recording indicates the presence of artifact which does not allow the algorithm to identify arrhythmias. Causes include wandering baselines. The anti-drift system largely prevents these disturbances. Check the electrodes and leadwires.

Final Report

The arrhythmia recording can be stopped with  .

Then the final report can be printed with . The final report consists of the following.

- Patient ID sheet (with all patient data as well as with all analyzed QRS complexes, type and number of detected events and the analysis duration in tabular form)
- Episode report (3 sheets maximum with 2 episodes each Arrhythmia codes)

Table 3. Arrhythmia Codes	
Arrhythmic Events	Acronym
Asystole, limit value 4 s	ASYSTO
Ventricular fibrillation/flutter	VFIB
Ventricular tachycardia (>3 PVCs)	VTAC
Ventricular run (3 PVCs)	RUN
Ventricular couplet (2 PVCs)	CPLT
Pause of 2 missed beats	PAU2
Pause of 1 missed beat	PAU1
Early PVC	EPVC
Ventricular bigeminy	VBIG
New form (e.g. intermittent bundle branch block)	NF
Multiform PVCs	MULT
Supraventricular arrhythmia	SVAR
Paroxysmal supraventricular tachycardia	PSVT
Tachycardia	TACH
Bradycardia	BRAD
Pacemaker malfunction	PERR
Ventricular escape beat	ESC
Premature ventricular contraction	PVC
Premature supraventricular contraction	PSVC
Aberrant beat	ABR
Pacemaker capture	PCAP
Pause (>1.5 times the normal RR interval)	TL
Absolute pause, limit value 3 s	PAUA
Artifact	A
Learn phase	L
Learned QRS complex	QRSL

For your notes

8 Stress Tests

For your notes

General Information

The Stress Test mode of the MAC 1200 ST allows you to run complete exercise tests. Depending on the connected exercise device (bicycle ergometer, treadmill, Master Step), the ECG unit will control the test to varying extents. In “Stress Test Sequences” on page 8-6 you will find descriptions of the test sequences with the different exercise devices.

NOTE

The Stress Test mode is only possible with MAC 1200 ST units with the ERGO option.

Before recording the first exercise test ECGs, the unit must be set up accordingly (e.g. by selection of the ergometer model and test protocol). Chapter 10, “Communication” describes how to configure the ergometer model. All other exercise-test related settings are described in Chapter 10, “Stress Test Mode” section.

WARNING

Before connecting peripheral devices to the unit, read the safety information in “Safety Information” on page 1-6.

During an exercise test the following occurs.

- The ST segment is analyzed in all 12 leads.
- 3 leads are shown on the display.
- 12 (selectable) leads are recorded.
- The ECG is continuously monitored for arrhythmias.

All relevant measurement results are stored and can be retrieved after the test.

The maximum length of an exercise test is 90 minutes. After the end of the test, the unit prints a final report. The report includes the following information.

- Patient data (summary)
- Tabular summary
- Graphic trends of the most important parameters
- ST summary
- Episode report

You can choose among the following test protocols.

Bicycle Ergometer

- WHO
- HOLLMANN
- BAL
- STD. FRANCE
- MODWO
- CONCONI

Treadmill

- BRUCE
- MODIFIED BRUCE (MODBRUCE)
- NAUGHTON
- ELLESTAD
- MODIFIED BALKE (MODBALKE)
- USAFSAM
- SLOW USAFSAM
- CORNELL
- BALKEWARE
- MODIFIED BALKEWARE (MODBALKEWARE)
- ADENOSINE
- DOBUTAMINE
- PERSANTINE

Master's Step Tests

- SINGLE
- DOUBLE
- TRIPLE

The following description is based on the factory default settings. For instructions on changing the default setup, refer to Chapter 10, “Stress Test Mode” section.

Table 1. Setup Menu for the Stress Test Mode		
Parameter	Factory Default	Options
Report Sequence	STANDARD	CABRERASEQ. No. 3
Protocol	WHO	see previous page
Rhythm Leads	I	II, aVF, V2, V4, V6
Gain	10 mm/mV	“auto”, 5, 20, 40 mm/mV
Speed	25 mm/s	50 mm/s
In-Test Reports	Comparative Median Report	Median Report
Muscle Filter	No	Yes
Muscle Filter Frequency	40 Hz	20 Hz
AC Filter	Yes	No
max. HR after	< 180	WHO 80%, WHO 90%, WHO 100%, AHA
J+x point formula	60	0, 20, 40, 80, Rautaharju, RR/16
Calculation (E-, J-point)	continuous	single
Arrhy Data	No	all, unequal
Final Reports		
Summary Report	Yes	No
Tabular Summary	No	Yes
Trend Reports	No	Yes
Trend Reports (ST)	No	Yes
ST Summary Report	No	Yes
Episodes	no	chron., prio, ventr

NOTE



If you wish to record an ECG only at the end of a test stage, you must enter a Medians Report time in the protocol editor (Chapter 10, “Stress Test Mode” section) that is 10 seconds shorter than the stage time.

Stress Test Sequences



The sequences of test phases and test protocols depend upon the exercise test device being used for the stress test.

Ergometers without Digital Communication Interface



With these ergometers, the test phases of the stored test protocols are the basis for the test sequence. This means that the protocol's initial load and load increases must be manually entered at the ergometer. Also manual intervention in the test protocol (such as increasing the load or sequencing to the next phase) must be repeated at the ergometer.

1. For *Ergom./Treadmill*, select *internal* or *remote start* (Chapter 10, "Communication" section).
2. Select the test protocol (Chapter 10, "Stress Test Mode" section) and set the corresponding initial load at the ergometer.
 - ◆ Press   to initiate the test. Wait approximately 30 seconds until the first ST measurements are taken.
 - ◆ Press  and ask the test subject to start pedalling.

Each time you reach the end of a load stage, you must set the load increase indicated by the program at the ergometer. As a general rule, all load changes implemented in the test protocol must be performed manually at the ergometer.

3. During the test, you can do the following.
 - ◆ Advance to the next load stage with .
 - ◆ Hold the current stage with .
 - ◆ Advance to the recovery phase with . (This happens automatically when the stage duration has elapsed.) Enter a stage duration under 99, because 99 = infinity.

End/Cancel a Stress Test

- ◆ End or cancel the test with  .

The following text appears on the MAC 1200/1200 ST display. Press the appropriate key to confirm or cancel the test end command.

Confirm Stop?

Onscreen:

On the keyboard:

Confirm: [Sensitivity]

Use the  key to stop the test.

Cancel: [Speed]

Use the  key to cancel the request to stop the test.
The test will continue.

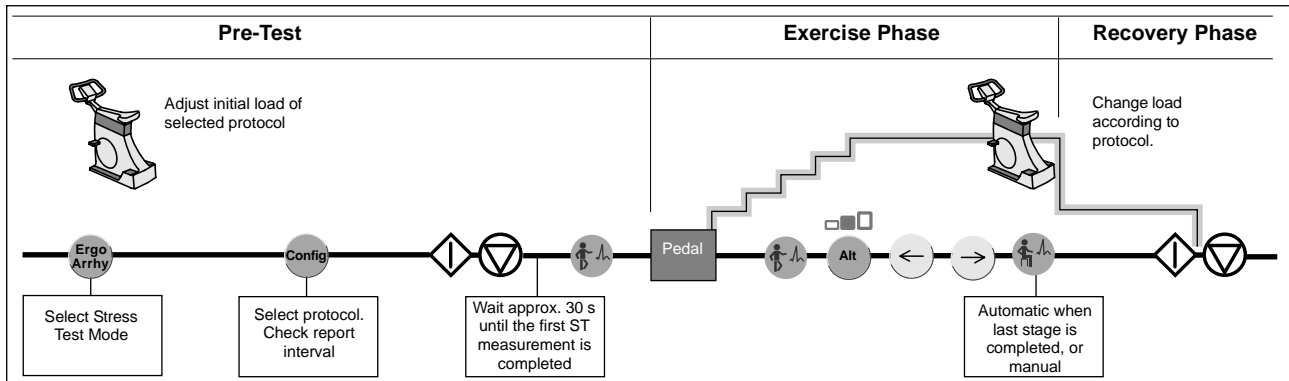

033A

Program Sequence for Ergometers Without Digital Interface

Ergometers with Remote Start Pulse

The remote start pulse of a connected ergometer initiates the following functions.

In Automatic mode	Start/stop
In Manual mode	Start/stop
In Arrhythmia mode	Event report
In Stress Test mode	Stage change

Action at Ergometer	Remote Start Pulse	Action at MAC 1200 ST
Test subject starts pedalling	1st remote start pulse	No action
Load increase at ergometer	Remote start pulse with each load increase	Stage change

Ergometers with Digital Communication Interface

Compatible ergometers include Variobike 500, 800, 900/900L, EC1200 V3.52, and Lode Excalibur/Sport.



With these ergometers, the selected protocol fully controls the test procedure. The ergometer operating controls are inoperative. Only blood pressure measurements can be taken manually.

NOTE

The EC1200 will display the version number when turned on. The following explanations refer to version 3.52 or higher (upgrade, if possible).

Blood pressure intervals are only valid for Ergoline 900.





The EC1200 with version 3.52 and later only supports directly connected blood pressure monitors. They are controlled by the stage time setting. The blood pressure interval will be ignored.

1. Select the ergometer type (Chapter 10, “Communication”).
2. Select the test protocol (configuration, Chapter 10, “Stress Test Mode”).
3. Press  . A blood pressure measurement is now taken automatically, if configured. Wait until the readings are available or until the first ST measurement is completed.

As trend values are saved at 30-second intervals, it is recommended that the test subject waits approximately 30 seconds before starting to pedal.

4. Ask the test subject to start pedalling.

Controls

- | | | | |
|---|--|---|---------------------------------|
|  | Holds the stage (must be pressed 5 seconds before the end of a stage at the latest). |  | Advances to the recovery phase |
|  | Stops or cancels the test. Refer to “End/Cancel a Stress Test” on page 8-7 for more information. |  | Advances to the next load stage |

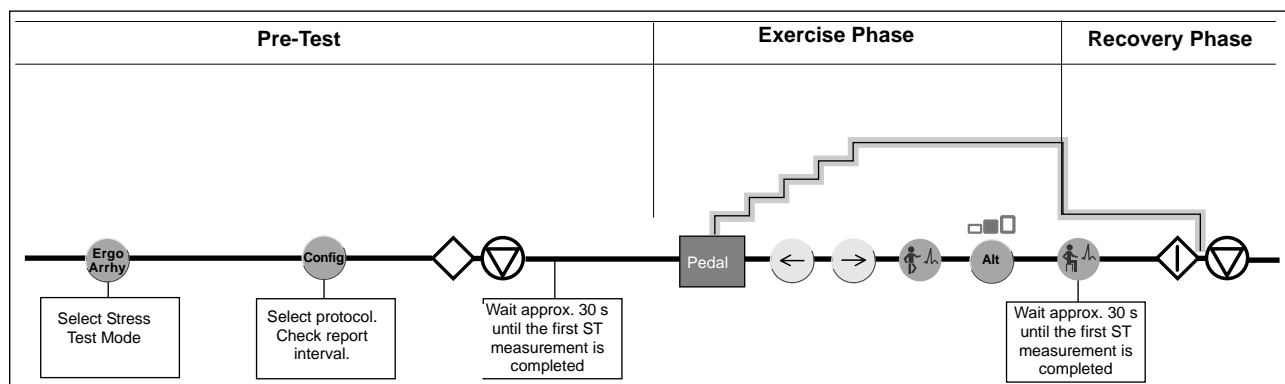



034A





Program Sequence for Ergometers with Digital Interface



NOTE



To start the exercise with the onset of pedalling, enter a stage time in the pre-test phase of 00:00. If another stage time is specified, the program waits for the button to be pressed. Then the exercise starts regardless of whether the test subject starts pedalling or not.



When you have configured the “internal” ergometer, the exercise can only be started with .

5. When you press  or , the program enters the manual mode and the phase name is given as “Manual”¹.

For safety reasons, the program maintains the current stage and the buttons  and  are inactive. You can only control the test manually with the buttons  .





6. When you press , the program increments to the next stage and a stage report is printed. With  you advance to the next phase.¹

With the EC1200,  takes you to the next higher stage and  to the preceding stage without generating a stage report. After a load change, wait until the new load appears in the display before you activate one of these buttons again.

When the number of revolutions is low, the EC1200 will automatically activate a load of 15 Watts and increase the load to the old value when the speed picks up again. During that time, the buttons , ,  are inactive and the program will not proceed to the next load stage.





¹ Does NOT apply to the EC1200.

Treadmill

1. Select the ergometer type (Chapter 10, “Communication” section).
2. Select the test protocol (configuration, Chapter 10, “Stress Test Mode” section).
3. Press  . At this stage, the resting ECG of the sitting patient is recorded. Continue collecting the ECG signal until the first ST measurement is completed or the results of the first BP measurement are available.
4. Press . At this point, the ECG of the patient standing upright is recorded.
5. Press .



Hyperventilating Patient

The next stage is reserved for a hyperventilating patient's ECG.

6. Start the treadmill with  and press . The warm-up stage follows, in which the patient gets used to the treadmill exercise.
7. Press . Once the patient is familiar with walking on the treadmill, initiate the actual test with .

From this point forward, the program controls the entire test including the recovery phase.











General Treadmill Considerations

- Stop the test at any time with  . Refer to “End/Cancel a Stress Test” on page 8-7 for more information.

NOTE

The treadmill can be stopped at any time with the emergency stop button.

- When using the treadmill model TM400E, it is important to adjust the same unit of speed measurement at the ergometer and at the CardioSys system (km/h or mph).

- If the speed is 0 in one of the stages, the treadmill switches off and can only be restarted with  .
- If the treadmill is stopped with  or with the emergency stop button, the speed and grade readout is “**.*”. Wait until this readout disappears before restarting the treadmill with  . Also remember to reset the emergency stop button.
- When you press  or  , the program enters the manual mode and the phase name is given as *Manual*. For safety reasons, the program maintains the current stage and the  button is inactive. You can only control the test manually with the  and  buttons (speed, grade). When you push  , the program increments to the next stage and a stage report is printed. With  you advance to the next phase.

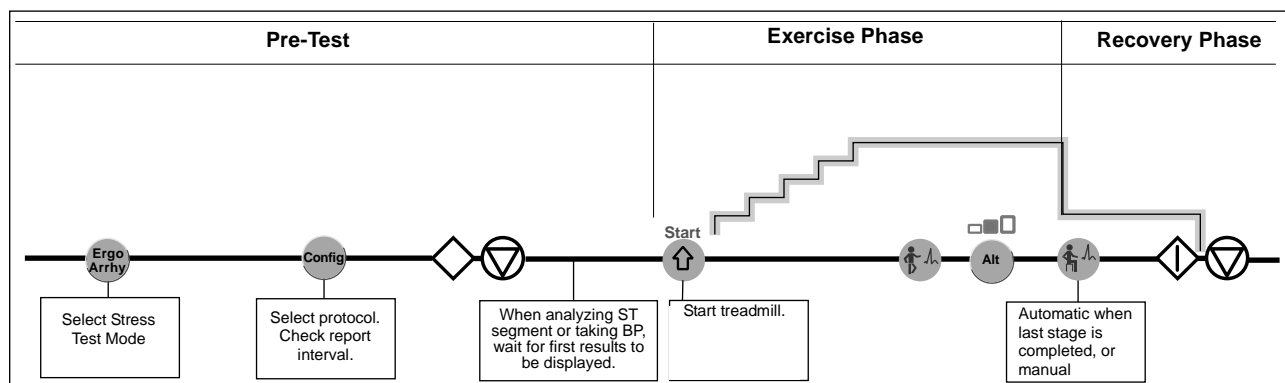

035A

Program Sequence for Treadmill Test

The Master's Step Test

Proceed as follows to use the Master's Step Test with the MAC 1200 ST.

Verify Device Settings



1. Press  to select the Stress Test mode.
2. Check the configured Ergometer type in the configuration menu under Chapter 10, "Communication" section. It must be set to *Master's Step Test*.
3. Check the configured Protocol in Chapter 10, "Stress Test Mode" section. It must be set to SINGLE, DOUBLE or TRIPLE.
4. Check the user-configured settings in the Stress Test configuration.
5. Check the correct connection of the Master's step device to the RS232 interface of the MAC 1200 ST.

NOTE

These settings need to be verified only once. They will be saved and are automatically available for further tests. The name of the test protocol is also annotated on the data acquisition screen.

Running the Test

1. Enter the patient information. (See Chapter 4, "Entering Patient Data" section for details.)

For the test the data fields *Date of birth*, *Gender* and *Weight* must be filled out. Otherwise the device will set the number of steps to the minimum value.
2. Apply the electrodes to the patient. If all electrodes are OK, press the  key.
3. The MAC 1200 ST prints a 12 Lead report. After 30 seconds the device prints a median report with the first ST measurement results.
4. Remove the electrodes for the exercise phase. Ask the patient to stand in front of the stair to start exercising.
5. Press . The Master's step device now activates the LEDs on the stairs on which the patient is expected to step. The duration of the exercise phase is 90 seconds (SINGLE test).

After the 90-second exercise time, the display indicates the current phase as POST EXERCISE and shows the message *ELECTR. ON* in place of the stage name.

6. Reapply the electrode. Press the  button when all electrodes are OK. The display now indicates the current stage as *POST EX 1*.
7. After 10 to 20 seconds the first median report is printed. The following reports will be printed after the pre configured interval time.
8. At the end of the test a summary report is printed with trends and tables.

User Actions During the Master's Step Test

During the test, you can change settings or initiate additional reports.



Initiates printout of a 12 Lead report.



Toggles between 25mm/s and 50mm/s.



Selects the gain: 5, 10, 20, 40 mm/mV.



Switches muscle filter ON/OFF.

HR+ /
HR-

Adjusts HR alarm limits.



Changes the number of passes in the PRE EXERCISE phase, depending on the selected Master Step mode, the number of passes changes as follows:



SINGLE: increments/decrements by 1 pass
DOUBLE: increments/decrements by 2 passes
TRIPLE: increments/decrements by 3 passes.



Selects the Master Step mode SINGLE (90 s), DOUBLE (180 s), TRIPLE (270 s) in the PRE EXERCISE phase.



When pressed in the EXERCISE phase, this button returns you to the ELECTRODE OFF stage of the PRE EXERCISE phase, where you can change the selected number of passes or the Master Step mode with the cursor keys. In stage 1 of the PRE EXERCISE phase the button advances to PRE EXERCISE stage 2.



When pressed while the test is on hold in the EXERCISE phase, the EXERCISE phase restarts. In stage 2 of the PRE EXERCISE phase, this button advances to the EXERCISE phase.



In the exercise phase, this button advances to the post-exercise phase. In the post-exercise phase, this button is pressed for the first time when all electrodes have been reapplied. After that, it can be pressed to initiate additional median beat reports



In the exercise phase, this button stops the Master steps ("stage hold"). When pressed again, the test continues. While on hold, the stage counter stops.

The Master Step Test (Default Protocol)



Phase	Stage	Name	Duration of Stage	Advancing to Next Stage	Reports
PRE-EXERCISE	1	SUPINE	until baseline ST is available	automatic	12-lead report at beginning stage report at end
	2	ELECTR. OFF	until button is pressed	with button	NO
EXERCISE	1	STEPPING	90, 180, or 270 seconds	automatic	NO
POST-EXERCISE	1	POST-EX1 ¹	3 minutes	automatic	stage report
	2	POST-EX2	2 minutes	automatic	stage report
	3	POST-EX3	2 minutes	automatic	stage report
	4	POST-EX4	2 minutes	automatic	stage report
	5	POST-EX5	2 minutes	automatic	stage report
	6	POST-EX6	2 minutes	automatic	stage report
	7	POST-EX7	2 minutes	automatic	stage report
	8	POST-EX8	2 minutes	automatic	stage report
	9	POST-EX9	2 minutes	automatic	stage report
	10	POST-EX10	2 minutes	automatic	stage report

1. In the POST-EXERCISE phase, the message ELECTR. ON is displayed instead of the stage name to prompt the user to reapply the ECG electrodes. The stage name reappears, when the user, having applied the electrodes, presses .

Creating Custom Protocols



The MAC 1200 ST allows the user to choose among three different test protocols. The default protocol is the SINGLE protocol with an exercise phase of 90 seconds. Also available in the list of protocols are the DOUBLE (180 seconds) and the TRIPLE (270 seconds) protocol.

The protocol can be selected as follows.

1. Press  and select *Stress test*.
2. Press . Now the configuration screen is displayed.
3. Move the cursor to “Protocol [others]” and press : the list of the available Master's step protocols is shown in the window.





SINGLE
DOUBLE
TRIPLE

You can also edit the parameters of the post-exercise phase as follows.

1. Press  and select *Stress test*.
2. Press . Now the configuration screen is displayed.
3. Move the cursor to *Protocol [SINGLE]* and press . The protocol editor is now active.

The protocol editor can be used to change the number of stages in the post-exercise phase and the duration of the individual stages. You can define between 1 and 50 stages. The minimum stage time is 30 seconds.

Running a Stress Test

1. Press  . This enables the passive mode.
2. Select the test protocol via  .
3. Enter patient data via  .
4. Apply the electrodes.
5. Initiate the stress test with   . The MAC 1200 ST will first record the 12-lead ECG. At the same time, the unit learns the patient's typical QRS complex. From this QRS complex, the unit derives the median complex which is the reference beat for calculation of the ST level and slope during the test.

The locations of all relevant device settings are shown below:

Operating mode	Muscle filter ¹	AC line filter ¹	Anti-drift system ¹	"Patient Name"
Report function ²	Gain		Report sequence	
Three leads display here				
Selected exercise test	Time since onset of test		Load	RPM
Phase	Time in phase			PVC/min
Stage	Time in stage			
Failure message ³			Current HR, [HR Limit]	

Stress Test Screen, Bicycle Ergometer

















1. if enabled
2. or *REC OFF* when the recording function is disabled
3. if any

Operating mode	Muscle filter ¹	AC line filter ¹	Anti-drift system ¹	"Patient Name"
Report function ²	Gain		Report sequence	
<p>Three leads display here</p>				
Selected exercise test	Time since onset of test		Speed	Grade
Phase	Time in phase		METS value	
Stage	Time in stage		PVC/min	
Failure message ³			Current HR, [HR Limit]	



Stress Test Screen, Treadmill





1. if enabled
2. or *REC OFF* when the recording function is disabled
3. if any

During the test you can do the following.

- Change the load in 5-Watt increments with   (not possible with all bicycle ergometers), or change the speed in steps, or deactivate the automatic load increase with .
- Change the treadmill grade in 0.1% increments with  .
- Advance to the next stage with , , .
- Advance to the next phase with , , .
- Start and stop the treadmill with , .
- Initiate additional report printouts with .
- Change the gain with .
- Stop the test with , .

NOTE



When you press  or , the program enters the manual mode and the phase name is given as *Manual*. For safety reasons, the program maintains the current stage and the  button is inactive.

You can only control the test manually with the  and  buttons (speed, grade). When you push , the program increments to the next stage and a stage report is printed. With  you advance to the next phase.



At the end of each load stage and, if configured, with the ECG interval, the recorder prints a 12-lead report and the median complexes of all 12 leads, including the ST measurement results.

Depending on what was selected in the *Setup* menu, this is either a *Comparative Medians Report* or a *Medians Report*.



NOTE

If the unit runs out of paper during the test, a message informs you of the problem. After inserting new paper, acknowledge the message with . Do NOT press , ; this will abort the test.

Ending the Stress Test

For automatically controlled program sequences, press the   after completing the last stage in the last phase to end the stress test. Refer to “End/Cancel a Stress Test” on page 8-7 for more information.

NOTE

If the stress test is aborted in the pretest phase with   , no automatic final report will be printed.

Final Report

Immediately after the end of the stress test, the unit will print the final report. The scope of this report can be selected in the configuration menu. The following reports are available.

Graded Summary Report

- Patient data
 - Analysis duration
 - Duration of pretest, exercise and recovery
 - Maximum HR, HR at rest
 - Maximum BP, BP at rest
 - RPP max.
 - ST / HR index = quotient of the difference of the ST depression at peak exercise and at the beginning of exercise and of the difference between the heart rate values at the same time
 - ST max. = lead with the max. ST depression of the whole test, the leads V1, aVR and aVL being excluded
 - ST recovery = lead with max. ST depression 3 minutes after the end of the exercise phase, the leads V1, aVR and aVL being excluded
 - Arrhythmia results: normal beats, artifacts, VBIG, PVC
 - PWC130, PWC150, PWC170 = watts per kg of body weight at HR 130, 150 and 170 (PWC = physical working capacity, for bicycle ergometers only)
 - METS = metabolic equivalent as a multiple of the oxygen consumption at rest
- $$\text{METS} = \frac{(\text{V [m/min]} \times 0.1 + (\text{slope [\%]} / 100) \times 1.8) + 3.5}{3.5}$$
- Median complexes (rest, peak exercise)

Graphic Trends, Standard

- HR / BP, load (for bicycle ergometers)
- Load / rpm (for bicycle ergometers)
- HR / BP, METS (for treadmills)
- Speed / slope (for treadmills)
- ST slopes, ST levels channel 1
- ST slopes, ST levels channel 2
- Heart rate, artifacts
- Paced beats, PVC

9 Pacemaker Patients / Recording During Defibrillation

For your notes

Recording ECGs of Pacemaker Patients

Due to the slow paper speed, it is not possible to display pacer pulses directly on the ECG recording. At a paper speed of 50 mm/s and a pulse duration of only 0.5 ms, the width of the recorded pacer pulse would be only 0.025 mm.

For this reason, the recorder reduces the pulse amplitude and expands the pulse width, so that the pacer pulse is easier to identify. The MAC 1200/1200 ST records the pulse with the correct polarity, with a width of 5 ms and with the same amplitude in all leads (depending on the polarity of the pacer pulse in leads I and II, the pacer pulse in lead III may be suppressed) The amplitude of the reverse current in the figure below shows an ECG recording with pacer pulses.

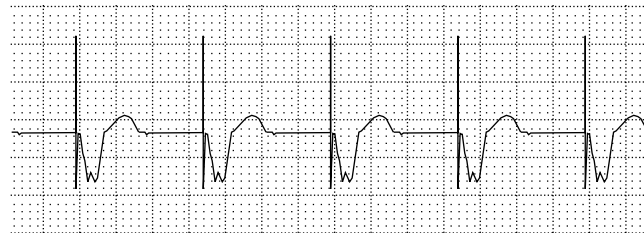

049A

ECG Recording with Pacer Pulses

WARNING

INCORRECT HR, NO HR ALARM — If several adverse conditions exist at once, the possibility that the pacer pulses are interpreted (and counted) as QRS complexes should be considered. At the same time, however, QRS complexes might be suppressed in certain situations. Therefore, pacemaker patients should always be watched closely.

ECG Recording During Defibrillation

The patient signal input is defibrillation-proof so it is not necessary to remove the ECG electrodes before defibrillating the patient. However, when using stainless steel or silver electrodes, the defibrillator discharge current may cause complete polarization at the electrode/skin interface. This condition may prevent ECG signal acquisition for several minutes. With silver/silver chloride electrodes, this will not happen.

Set the MAC 1200/1200 ST to Manual mode when you may have to defibrillate the patient while recording the ECG, and disable the anti-drift system which would cause a 2 second signal delay (Chapter 10, "Manual Mode" section for details).

When using other electrodes, disconnect the patient cable from the recorder while defibrillating the patient.

WARNING

EQUIPMENT DAMAGE — For reasons of patient safety, use only the original GEMS IT patient cable. Before connecting the cable to the de-vice, check it for signs of mechanical damage. Do not use a damaged cable.

PATIENT HAZARD, DELAYED ECG DISPLAY — Use silver/silver chloride electrodes for ECG signal acquisition, if the patient may have to be defibrillated.

SHOCK HAZARD — During defibrillation, do not touch the patient, the electrodes or the leadwires.

NOTE

Observe the defibrillator safety information.

10 System Setup

For your notes

General Information

- Press  to display the configuration menu.



The main menu with the following options will appear.

- Operating mode: Automatic (Manual, Arrhythmia, Stress Test)
- System Setup
- Communication
- Patient Data Setup
- Option Code





At “Operating mode”, you will always see the currently selected mode. So be sure to select the appropriate mode before entering the configuration menu.

- To access the menu options, position the bar cursor on the option with the cursor keys and confirm the selection with .

The operating steps to select a setting are always the same.

- Using the cursor keys  and , you select the setting and confirm the selection with .

The cursor will move to the next menu item.

- Individual items can be skipped with  or .
- To exit the menu, press  or .

The factory default setting is shown in angular brackets [...].

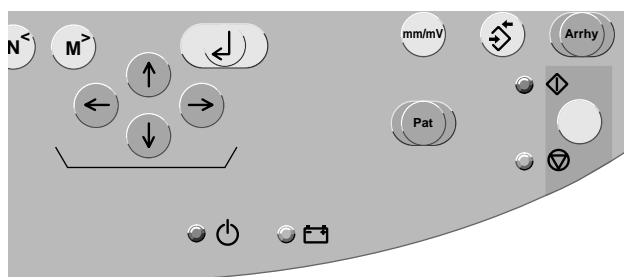

045A

System Setup Keys

Automatic Mode

Use the cursor keys to position the bar cursor on *Automatic* and confirm the selection with .

The configuration menu for the Automatic mode will appear.

Report Sequence

[STANDARD] (I, II, III, aVR, aVL, aVF, V1, V2, V3, V4, V5, V6)

CABRERA (aVL, I, -aVR, II, aVF, III, V1, V2, V3, V4, V5, V6)

NEHB (I, II, III, aVR, aVL, aVF, D, A, J, D, A, J) (only measured with the HEART interpretation program)

Rhythm Leads

Depending on the selected report format, the recorder will print 0, 1, 3 or 6 selectable rhythm leads.

With the 12_F1 report format, the printed rhythm lead is V6 (for NEHB leads: lead J), with formats 3_F1, 6_FS, and 6_F1, the first (selected) rhythm lead, with formats 1x10R3 and 4x2.5R3 the first 3, and with formats H1 and A1 all 6 rhythm leads.

Gain

5, [10], 20, 40 mm/mV, *auto

Report Format

Refer to Chapter 5, “Report Formats” section.

Detailed Results (MAC 1200 / 1200 ST Only)

The *Detailed results* page will be printed, yes/[no] (Chapter 5, “Report Formats” section).

Continuous Rhythm

[yes]: In 6_F1 reports, the first 6 leads represent the first half of the 10-second signal acquisition period, while the second set of 6 leads represent the 2nd half of the acquisition period.

no: The second set of 6 leads also represents the first half of the acquisition period.

The same is true for the report format 3_F1.

NOTE

When you select *Continuous rhythm = yes*, the letter R will be appended to the report name. Report formats 6_F1, 3_F1, 4x2.5R3, 6_F2, H2 become 6_F1_R, 3_F1_R, 4x2.5R3_R, 6_F2_R, H2_R.

Muscle Filter/AC Filter

Elimination of muscle artifact and AC line interference.

- Muscle filter: [no],
- AC line filter: [yes]

NOTE

Filters may suppress diagnostically relevant portions of the signal, because they limit the transmission range. Therefore, only enable filters if necessary.

Muscle Filter Frequency

Cut-off frequency of the muscle filter: [40 Hz], 20 Hz.

The frequency range is indicated in the lower margin of the recording strip.

- 0.08 – 40 Hz (40-Hz muscle filter enabled)
- 0.08 – 20 Hz (20-Hz muscle filter enabled)
- 0.08 – 150 Hz (muscle filter off).

Manual Copy To

When the  key is pressed, the unit will print a copy of the ECG [ECG], or the ECG is sent to a host system (CardioSys, CardioSoft, and/or MUSE CV systems).

Number of Copies

If you do not want to print the ECG, but only collect data or send the ECG to a PC, select 0 (message on display: *REC OFF*). When a number greater than 1 is selected, multiple copies of the reports will be printed. Default: [1]

Delete ECG After Transmission

(MAC 1200/1200 ST with Memory Option MEMO Only)

Stored ECGs that were successfully sent to a host system via the RS232 interface will be cleared from the recorder memory. Default: [no]

If this menu item is set to *Yes* and ECGs have already been sent from the recorder memory, these ECGs will be deleted after the next transmission of a stored ECG.

Autosave ECG

(MAC 1200/1200 ST with Memory Option MEMO Only)

After report generation, the ECG will or will not be automatically saved to the internal memory: [no], yes.

Interpretation

If *Yes* is selected, the unit will generate an interpretation of the ECG data.

Print Interpretation

If *Yes* is selected, the interpretation will be printed with the report.

Interpretations will always be sent to CardioSys, CardioSoft or MUSE system regardless of the Print Interpretation setting.

Override Function [no]

When this function is enabled [yes], the recorder will print in Automatic mode, even when not all electrodes are applied or do not supply a good signal.

When electrodes are disconnected, a message informing the user of poor signal quality will be printed on the recording strip.

Measurement and interpretation results may be adversely affected by disconnected electrodes.

Manual Mode

Use the cursor keys to position the bar cursor on *Manual* and confirm the selection with .

The configuration menu for the Manual mode appears.

Report Sequence

[STANDARD] (I, II, III, aVR, aVL, aVF, V1, V2, V3, V4, V5, V6)

CABRERA (aVL, I, -aVR, II, aVF, III, V1, V2, V3, V4, V5, V6)

NEHB (D, A, J, I, II, III, aVR, aVL, aVF, D, A, J)

SEQ. NO. 4 (Users can define a custom report sequence here):

- Position the cursor on *SEQ. NO. 4*.
- Press .

The display shown below will appear.

Report sequence	SEQ. NO. 4	
	Lead	Label
Channel 1:	I	I
Channel 2:	II	II
Channel 3:	III	III

- ◆ Press .

The cursor will move to the position for entry of the lead in channel 1. Follow these steps, if you wish to record lead aVR in channel 1, for instance.

1. Enter AVR and confirm the entry with .

The cursor moves to the position for entry of the lead designation. AVR appears there as well.

2. To enter another designation, you can overwrite the default name (4 characters maximum).
3. Confirm your entry with . Repeat the above steps for channel 2, etc.

You can write over "SEQ. NO. 4" if you wish to enter another name for the report sequence.

Gain

The unit will automatically determine the appropriate gain setting for the 6 simultaneous leads ("auto", 5, [10], 20, 40 mm/mV; with "*auto").

Speed

Changes the paper speed (Default: [25 mm/s]).

Muscle Filter/AC Filter

Elimination of muscle artifact and AC line interference.

- Muscle filter: [no], AC line filter: [yes]

Muscle Filter Frequency

Cut-off frequency of the muscle filter: [40 Hz], 20 Hz.

The frequency range is indicated in the lower margin of the recording strip.

- 0.08 – 40 Hz (40-Hz muscle filter enabled)
- 0.08 – 20 Hz (20-Hz muscle filter enabled)
- 0.08 – 150 Hz (muscle filter off).

Anti-Drift System (ADS)

In case of wandering baselines, the anti-drift system restores the baseline to its original position. Signal delay with ADS approximately 2 seconds (Default: [no]).

Auto Paper Feed

Before each recording, the recorder feeds the paper to the beginning of a new page ([yes], no).

Arrhythmia Mode

Use the cursor keys to position the bar cursor on *Arrhythmia* and confirm the selection with .

The configuration menu for the Arrhythmia mode will appear.

Report Sequence

STD_C: V1, V2, V3, V4, V5, V6

STD_RED: I, II, III, V2, V4, V6

STD_LI: I, II, III, aVR, aVL, aVF

CABR_LI: aVL, I, -aVR, II, aVF, III

NEHB: I, II, III, D, A, J

HIGH_C: V1', V2', V3', V4', V5', V6'4 (you can configure a custom sequence with these leads):

- Position the cursor on *HIGH_C*.
- Press  and create the report sequence as described in “Manual Mode” section.

Gain

The unit will automatically determine the gain setting (*auto, 5, [10], 20, 40 mm/mV; with “*auto”).

Muscle Filter

Elimination of muscle artifact: yes, [no].

AC Filter

Elimination of AC line interference: [yes], no.

Muscle Filter Frequency

Cut-off frequency of the muscle filter: [40 Hz], 20 Hz.

The frequency range is indicated in the lower margin of the recording strip.

- 0.08 – 40 Hz (40-Hz muscle filter enabled)
- 0.08 – 20 Hz (20-Hz muscle filter enabled)
- 0.08 – 100 Hz (muscle filter off).

Trend Recording

The slow trend recording of 5 mm/s automatically begins at program start ([no]/yes).

Arrhythmia Data

The recorder will document arrhythmias in the following situations (all [unequal], no).

- Each time an arrhythmia occurs.
- Each time an arrhythmia occurs that is different from the preceding event.
- Arrhythmias are not documented.

Episodes

Final report includes episode report, with episodes listed by one of the following criteria ([chron.], prio., ventr., no.).

- In chronological order
- According to priorities (see Table 3, “Arrhythmia Codes,” on page 7-9)
- Ventricular beats only
- No episode report

Stress Test Mode

Report Sequence

[STANDARD] (I, II, III, aVR, aVL, aVF, V1, V2, V3, V4, V5, V6)

CABRERA (aVL, I, -aVR, II, aVF, III, VI, V2, V3, V4, V5, V6)

SEQ. NO. 3 (Here, users can define a custom report sequence.)

- Position the cursor on *SEQ. NR 3*.
- Press  and create the report sequence as described in “Manual Mode” section.

Protocol

The test protocols available for selection depend on the selected exercise test device (see “Communication” section).

The Protocol Editor allows you to change individual test parameters or to create your own test protocols.

- First select the protocol that you would like to edit or which is similar to the one you want to create.

- Push  to open the Protocol Editor window.

Configuration: Stress Test			
Protocol:		WHO	
[add phase]	add stage	add proto	
del phase	del stage	del proto	
print proto	reset proto	ok	escape
Phase	Time In	Basic Lead	Median Repo
STAGE	99:00 ¹	0	First
PRETEST	Ramping	0	
	00:00	0	:
EXERCISE	Ramping		
STAGE 1	2:00	25 ²	1:50
STAGE 2	2:00	50	1:50
STAGE 3	2:00	75	1:50
STAGE 4	2:00	100	1:50
STAGE 5	2:00	125	1:50
STAGE 6	2:00 ³	150	1:50 ³
STAGE 7	2:00	175	1:50
STAGE 8	2:00	200	1:50
STAGE 9	2:00	225	1:50
STAGE 10	2:00	250	1:50
STAGE 11	2:00	275	1:50
STAGE 12	2:00	300	1:50
STAGE 13	2:00	325	1:50

Protocol Editor Window

1. A stage time of 99.00 means an indefinite stage time and the program does not automatically advance to the next stage
2. Values for Ramping are 1 or Yes and 0 or No. Ramping = Yes means the load increases evenly
3. If the time for the first stage report is longer than the stage time, no stage report will be printed.

The protocol editor has the form of a table. It lists all parameters of the protocol: names of the protocol, phase and stage, load parameters (depending on exercise test device), intervals for the output of reports, intervals for blood-pressure measurements).

The command menu is shown at the top of the display.

When the editor screen is opened, the cursor highlights the protocol name (e.g. WHO). With the cursor keys, the cursor can be positioned on the different commands.



When the cursor is in the bottom line of the command menu, it can be positioned in the table with . When the cursor moves beyond the borders of the screen, the table position changes accordingly. The column listing the stage names, however, does not change so that users will not lose track of the stage they are in.

With the key combinations



the table can be repositioned by the width/height of a full screen.

Editing Parameters

- Position the cursor on the value to edit and press .
- Enter the new value and confirm the entry with .

Adding a Phase

A phase can only be added when there are less than 3 phases to the protocol. The phase names begin in column 1, the stage names in column 2. A new phase is always added before the phase where the cursor is currently located (the cursor may be located on any stage).

1. Push .



The cursor moves to the command menu.

2. Position the cursor on [add phase] and confirm with .



A list with the existing phases appears.

3. Select the desired phase and confirm with . The phase is added to the table.



Deleting a Phase

1. Delete the phase to delete and confirm with . The cursor moves to the command menu.
2. Position the cursor on [del phase] and push .
3. Confirm the delete command with .



Adding a Stage

1. Select the stage that is to follow the new stage and push . The cursor moves to the command menu.
2. Position the cursor on [add stage] and confirm with . A copy of the stage to edit is added.

Deleting a Stage

1. Select the stage to delete and confirm with . The cursor moves to the command menu.
2. Position the cursor on [del. stage] and push .
3. Confirm the delete command with .

Creating a New Protocol

1. Position the cursor on [new proto.] and push . A screen appears showing 3 command buttons and a list of all existing protocols.
2. Select a protocol (in the figure on the next page, protocol 4 *STD FRANCE* is selected) and confirm with .
3. Position the cursor on [new proto.] and confirm with .

You will see the Protocol Editor with the parameters for *STD FRANCE*. Question marks appear in place of the protocol name. You can overwrite them with a name of your choice. The test parameters can be edited as needed.

Resetting the Protocol

With the *reset proto.* command, you can restore all parameters to the values that were active when you first called up the protocol editor.

Printing the Protocol

Initiates a printout of the displayed protocol.

Saving the Protocol (OK)

With *OK*, you save the displayed protocol.

Quitting the Protocol Editor

With the *Escape* command, you quit the Protocol Editor. Changes to the parameter values will be ignored and are not saved.

Factory Defaults for Protocols

The factory defaults for treadmill and bicycle ergometer protocols can be reactivated.

CAUTION

New protocols will be deleted, therefore print your custom protocols before the reset.

To reactivate factory defaults for treadmill and bicycle ergometer protocols, position the cursor on the Protocol selection field and press



Rhythm Leads

6 leads of your choice for recording of the 6-lead event report.

Gain

When you select **auto* the program will automatically determine the optimal gain setting (**auto*, 5, [10], 20, 40 mm/mV).

Speed

Writer speed in mm/s for the printed reports.

In-Test Reports

Format of the In-Test Reports.

- Median Report
- [Comparative Median Report]

Muscle Filter/AC Filter

Elimination of muscle artifact and AC line interference.

- Muscle filter: [no], yes
- AC line filter: [yes], no

Muscle Filter Frequency

Cut-off filter frequency of the muscle filter (20 Hz, [40 Hz]).

Maximum HR After

For selection of the maximum permitted heart rate:

- [<180]
- WHO 80%: 180 - patient age
- WHO 90%: 200 - patient age
- WHO 100%: 220 - patient age
- AHA
 - ◆ (age below 25 years: 160,
 - ◆ age from 25 to 75 years: $160 - [(age - 25) \times 45/50]$
 - ◆ age above 75: 115

J+x Point Formula

0, 20, 40, [60], 80, Rautaharju, RR/16

Calculation (E, J Point)

The E and J point position are either calculated once “single” or [continuously].

Arrhythmia Data

The recorder will document arrhythmias in the following situations (all, unequal, [no]).

- Each time an arrhythmia occurs.
- Each time an arrhythmia occurs that is different from the preceding event.
- Arrhythmias are not documented.

Final Reports

The Final Reports setup determines the scope of the final report.

- Summary report [yes] / no
- Trend report yes / [no]
- Trend report ST yes / [no]
- Sample cardiac cycles yes / [no]
- Tabular summary yes / [no]
- Episodes (documentation of event episodes in chronological order, according to priorities, ventricular events only, or [no] documentation.

System Setup

Ordering Physician/Referring Physician/Technician



In the leftmost field, the last name of the physician or technician selected as the default name is shown.

When *other* is selected, a menu to enter up to 10 names (4-digit ID number, first name, last name) is shown. The default name (and ID) is automatically selected at power-up.

NOTE

Physician and technician numbers must be unique (the system will accept non-unique IDs).

The *Referring Physician* is only relevant if ECGs are sent to the MUSE CV system. This name will not be annotated on the ECG recording. To

exit the menu, press  .

Institution Name

The name entered here will be printed on each report page.

Cart Number *

4-place number, default: 1, range: 1 to 9999.

Site Number * **

number of the MUSE CV system that is to receive the data, default: 1, range: 1 to 255.

*The value selected here is the default value appearing in the patient data

**with CSI protocol only

Location*

3-place ID number of the location to which the ECG recorder is assigned, default: 1, range: 1 to 600.

Date/Time

Enter date and time (enter 4 digits for the year).

Lead Fail Beep

Audio signal to indicate electrode problems (yes, [no]).

High HR Beep

Audio signal to indicate that the heart rate exceeds the limit value: yes, [no] (only in Manual and Arrhythmia modes). The limit value (220 - age) can be changed manually.

1. The value selected here is the default value appearing in the patient data
2. with CSI protocol only

Lead Labels

[IEC codes]: R, L, F, N, C1 to C6 or

AAMI codes: RA, LA, RL, LL, V1 to V6

Pace Enhancement

Pacer pulses are displayed enhanced and with a given amplitude ([yes], no).

When programming pacemakers, we recommend to disable the pace enhancement.

Baseline Roll Filter

Select the lower cut-off frequency: = 0.04, [0.08], 0.16 Hz.

Date

Format: day.month.year or month/day/year.

Time

Time format: [24 hours] or 12 hours (am/pm).

Units

Units of measurement for the patient's height and weight: [cm/kg] or in/lb.

Mains

AC line frequency: Europe [50 Hz], USA 60 Hz.

LCD Light Off After

If operating controls are not activated within the selected period of time the display backlighting automatically switches off (system default [20 min], adjustment range 1 to 99 min).

Low Battery Beep

Intermittent audible signal indicating that the battery requires charging. The interval time for the tone can be selected between 5 and 60 seconds.

[0 s] = no audio signal.

Beep for Master Step

[no] / yes. This field appears only if the selected exercise test device is the MASTER STEP. When you choose "yes", the MAC 1200 ST will emit beeps to control the exercise speed for the Master Step test.

Default mode

This is the operating mode the unit defaults to after power-up: [Automatic].

Language

To select the language.

Enable Password Protection

Select *Yes* to protect the setup menu with a password. You will be asked to enter a password and to repeat it. Then password protection is active.

To change the password (only possible when password protection is active), do the following.

1. Select menu item *Enable password*.
2. Enter the old password.
3. Enter the new password.
4. Repeat the new password.

Test Data

Used for demonstration purposes (yes). It should be set to [no] (default) for proper clinical use.

Restore Defaults

Selecting *Yes* will restore the factory default settings (including the defaults of the three operating modes).

The electrocardiograph must be switched off and on again for the new settings to become effective.

Print Configuration Lists

Selecting *Yes* will display a menu with all available configuration lists.

- All lists
- System Setup/Communication/Peripheral Devices/Patient Data



Setup

- Automatic
- Manual
- Stress Test
- Arrhythmia

Transmission Log

After each transmission of ECG records, the MAC 1200/1200 ST unit can generate a transmission log report. This report includes a list of the ECG reports transmitted.

To enable the transmission log function, follow these steps.



1. Within the *System Setup* window, move the cursor to the prompt *Enable the Print ECG Tx. Log.*
2. Select *Yes*.
3. Save this setting by pressing  .

Check Record Retxn

If a user attempts to transmit a record that has already been transmitted when the *Check Record Retxn* function is enabled, a message displays informing the user that this record has already been transmitted.

The *Check Record Retxn* function defaults to *No*.

To enable the *Check Record Retxn* function, follow these steps.

1. Within the *System Setup* window, move the cursor to the prompt *Check Record Retxn.*
2. Select *Yes*.
3. Save this setting by pressing  .

Communication

Baud Rate (PC)

Transmission rate for the selected protocol. We recommend the default setting of [19200 baud].

Protocol

The recorder offers two communication protocols: "A5" and "CSI" (Client Server Interface, MAC 1200 / 1200 ST only).

With the "A5" protocol, the 10-second resting ECG can be transmitted to CardioSys and CardioSoft.

The CSI protocol supports the transfer of resting ECGs from the electrocardiograph to a MUSE CV system.

Modem

Select the modem type. Choose among the standard modems MultiTech (MT 19.2, 56k), Elsa 14.4, 28.8, 33.6, 56k and a user-defined modem.

When using one of the standard modems, enter is the following:

- The dial mode (pulse or tone, depending on your telephone network).
- The telephone number (20 digits maximum).
- The number to access the public telephone network (e.g. "0").



For a user-defined modem, enter the following:

- The telephone number (20 digits maximum).
- The init string (20 characters maximum). (See modem operator's manual.)
- The dial string (20 characters maximum). (See modem operator's manual.)
- The hangup mode (20 characters maximum). (See modem operator's manual.)

PIN Dialing

The MAC 1200/1200 ST can be set up so a facility can dial in with a PIN (Personal Identification Number) and a calling card.



To enable the PIN dialing function, follow these steps.

1. Within the *Communication Setup* window, select the appropriate modem.
2. Move the cursor to the prompt *PIN Dialing*.
3. Select *Yes*.
4. Enter information for the following fields:
 - ◆ *Delay* (ddddd)
 - ◆ *Service provider* (sssss)
 - ◆ *PIN* (pppppppp)
 - ◆ *Phone number* (xxxxxx)
 - ◆ *Outside line* (yyyyyy)
5. Save this setting by pressing  .

Manual Dialing

The MAC 1200/1200 ST can be set up so a facility can manually dial in to transmit ECG records.

To enable the manual dialing function, follow these steps.

1. Within the *Communication Setup* window, select *CSI/A5 Protocol Select*.
2. Move the cursor to the prompt *Manual Dialing*.
3. Select *Yes*.
4. Save this setting by pressing  .

Ergometer/Treadmill

Options: [internal], Other. Choose the exercise test device used. Selecting *Other* will open a window where you can choose the appropriate option.

Confirm your selection with  .

Patient Data Menu Setup

The patient data menu can be set up to meet individual requirements. If you do not want to enter blood pressure readings, for instance, you can remove the corresponding prompts from the menu.

1. Use the cursor keys to position the bar cursor on *Patient Data Setup* and confirm the selection with . The patient data setup menu will appear.
2. Select *No* for prompts that you want to remove from the dialog. The following items cannot be removed.
 - ◆ Name
 - ◆ First name
 - ◆ Date of birth
 - ◆ Patient ID
3. The following items are disabled. They can be enabled from this menu.
 - ◆ ID required (ID = patient ID number)
 - ◆ Secondary ID
 - ◆ Secondary ID required
 - ◆ Last name required
 - ◆ First name required
 - ◆ Location Number
 - ◆ Room
 - ◆ Order Number
 - ◆ Prompt 1 to 4

The patient ID length is configurable from 3 to [16] characters.

Required Data Fields

If you choose *Yes* for one of the data fields, an ECG can be recorded in Automatic mode only if the corresponding patient data is entered. Fields on patient data entry screens that require an entry, are identified with pointed brackets (e.g. Last name: >.....<).

- ID required
- Secondary ID required

NOTE



If Secondary ID is specified as a required data field, make sure that it is not configured out of the patient data set up (see “Patient Data Menu Setup” on page 10-29 for more information).

- Last name required
- First name required

Prompts 1 to 4

Enter any text here (10 characters maximum). When you have entered the text, you can select the format of the response field. There are 3 formats:

- Alphanumeric field (17 characters maximum)
- Only numbers (9 numbers maximum)
- Yes or No

To exit the menu, press  .

Option Code

In this menu you enter option codes to activate a number of optional software functions. The respective option becomes active after you have entered the code number. The code numbers are listed on the option code sheet supplied with the different software options.

1. Use the cursor keys to position the bar cursor on *Option Code* and confirm the selection with .

The menu for entry of the option code will appear. There is a choice of seven optional programs.

MEAS: measurement of the 10-second resting ECG

DIAG: measurement and interpretation of the 10-second resting ECG



MEMO: storage of up to 40 resting ECGs

C100: activates the three options MEAS, DIAG, MEMO for a maximum of 100 ECGs







C500: activates the three options MEAS, DIAG, MEMO for a maximum of 500 ECGs

EVAL activates the three options MEAS, DIAG, MEMO for a period of 4 weeks

ERGO stress test (MAC 1200 ST only)



- Using the cursor keys, position the bar cursor on the option that you want to activate.
- Enter the 12-digit code number and confirm the entry with .
- The unit will accept the entered number only if it corresponds to the unit's serial number. The serial number is indicated at the top of the menu (Serial Number = xxxxxxxx). This number must be the same as printed on the nameplate (back of the device).
When you enter the code number for DIAG and MEMO, the fields for C100, C500 and EVAL will disappear.
- Select   to close the submenu.

ECG Transmission via Modem



- Select the Automatic mode and press .
- Press  to display the configuration menu for Automatic mode.
- Use the cursor keys to position the bar cursor on *Manual copy to HOST* and confirm the selection with  ([HOST]).
- Press   to clear the configuration menu.
- Use the cursor keys to position the bar cursor on *Communication* and confirm the selection with .

Selecting the Communication Protocol







This adjustment is only necessary with MAC 1200/1200 ST units, because only these devices can send data to CardioSys/CardioSoft or to MUSE. For MAC 1100 units that can send data only to CardioSys/CardioSoft, the communication protocol A5 is preselected.

- Use the cursor keys to position the bar cursor on *Protocol*. Select the protocol A5 if you will send data to CardioSys/CardioSoft, or select CSI to send data to MUSE.
- Use the cursor keys to position the bar cursor on *Modem, other* and confirm the selection with .
- Choose the modem you use from the list and confirm the selection with .

If your modem is not included in the list, select *other* and enter the required modem commands (see Chapter 5, “Modem Setup (for Modem Æ Other)” section).

- When you have selected a standard modem, position the bar cursor on *Dial mode* and select the appropriate mode.
- Enter the telephone number of the receiving modem and the number to access the public telephone network and terminate the configuration with  .

Direct ECG Transmission

- Select the Automatic mode and press .
- Press  to display the configuration menu for the Automatic mode.
- Use the cursor keys to position the bar cursor on *Manual copy to HOST* and confirm the selection with  ([HOST]).
- Press   to clear the configuration menu.
- Use the cursor keys to position the bar cursor on *Communication* and confirm the selection with .
- Select the same baud rate as at the receiving modem (2400, 4800, 9600, 19200, 38400, 57600).

Selecting the Communication Protocol

This adjustment is only necessary with MAC 1200 / 1200 ST units, because only these devices can send data to CardioSys/CardioSoft or to the MUSE system. For a MAC 1100 unit that can send data only to CardioSys/CardioSoft, the communication protocol A5 is preselected.

1. Using the cursor keys, position the bar cursor on *Protocol*.
2. Select the protocol A5 if you will send data to CardioSys/CardioSoft system or select CSI to send data to MUSE system.
3. Use the cursor keys to position the bar cursor on *Modem, none* and confirm the selection with .

11 Loading Chart Paper

For your notes

Procedure

1. Switch on the recorder.
2. Holding the paper door at the handle, pull it up and fold it out.

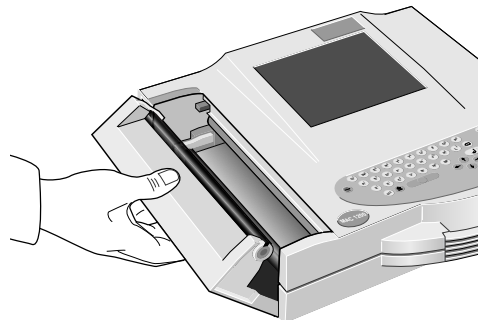

049A

Opening the Paper Compartment Door

3. Remove the cardboard backing of the previous paper pad.
4. Remove the cardboard from the top of the new pad and place the pad, including the cardboard backing at the bottom and with the arrow pointing towards the unit, into the paper compartment.

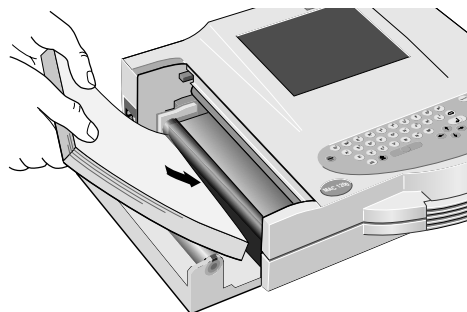

050A

Inserting the New Z-fold Pad

5. Pull the top sheet from the compartment and guide it around the guide roller.

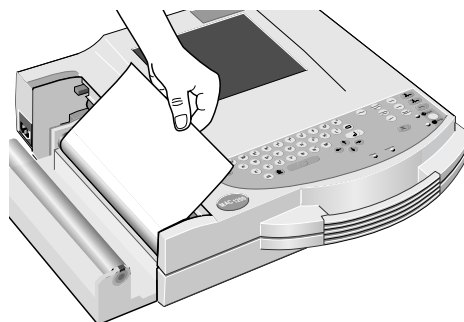

051A

Guiding the Leading Paper Edge Over the Guide Roller

6. Holding the leading edge of the paper in place between the two markers on the recorder, close the paper door.

NOTE

To ensure proper printer operation, the latches at both end of the paper door must be secured. Listen for clicks as you close it to ensure that it locks into place on both sides.

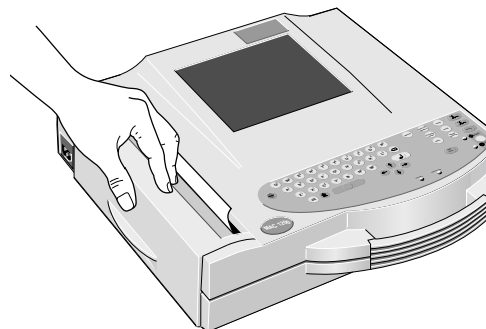

052A



Closing the Paper Compartment Door

NOTE

When inserting an already started Z-fold pad, the grid side must face up and the first fold must point toward the paper compartment.

End-of-Paper Indication

NOTE

After inserting a new paper pad, be sure to acknowledge the *End of paper* message with , not with  .

NOTE

When closing the paper door, take care that it locks into place on both sides.

There is a window in the paper door that allows you to look inside the compartment and check the paper supply.



CAUTION

Use only the original GE Medical Systems *Information Technologies* writer paper. This paper has a special coating that prevents contamination and debris collecting on the printhead and electrostatic build up.

Furthermore, the thermosensitive layer and the printhead characteristics are exactly matched. Using other paper may result in recordings of poor quality. Moreover, the printhead may wear out prematurely.

Use of other paper may void the warranty.

A stripe marks the last 10 pages of the Z-fold pad.

When the writer runs out of paper during a recording, it will emit an audio signal and displays the message *End of paper* or *paper jam*. If OK, press . Insert a new paper pad and acknowledge the message with .

Aging Stability

The standard ECG writer paper CONTRAST® is designed to guarantee full contrast for a period between 1 and 5 years if it is handled as described below before and after recording.

- Avoid continued, direct exposure of the paper to sunlight and other UV radiation and fluorescent light.
- Store the paper in suitable rooms at a temperature between 18°C and 24°C and a relative humidity between 40% and 60%.
- Avoid direct contact of the paper with carbon and carbonless forms, chart papers and adhesives containing tributyl phosphate, dibutyl phthalate, or any other organic solvents, and document protectors, envelopes, and sheet separators containing plasticizers. Solvents or solvent-based products containing alcohols, ketones, esters, or other substances from this chemical group.

CAUTION

The above components may also be found in recycled papers.

- Archiving ECG recordings on our ECG filing cards only (P/N 217 043 03 is recommended).
- If longer storage periods are required, use our ARCHIVIST chart paper (image legibility up to 15 years) or other image storage technologies.

12 Cleaning, Disinfection and Maintenance

For your notes

Cleaning and Disinfecting the Recorder Housing

WARNING

SHOCK HAZARD — Disconnect the device from the power line before cleaning or disinfecting its surface.

Wipe the monitor clean with a moist cloth. Do not let liquid enter the monitor. All cleaning agents and disinfectants that contain alcohol and are commonly used in hospitals are suitable, but do not use disinfectants with a phenol base or peroxide compounds.

Cleaning and Disinfecting the Patient Cable

- Disconnect the cable from the recorder before cleaning or disinfecting it. When disconnecting the cable, be sure to pull on the connector, not on the cable.
- Clean the cable by rubbing it down with a cloth moistened with soap water. Use a disinfectant for disinfection. Do not immerse the cable in liquid.

Cleaning and Disinfecting the Electrodes

In addition to the information given in this manual, observe the instructions for use of the respective electrode types.

- Discard disposable adhesive electrodes immediately after use to prevent that they are reused.
- Clean reusable electrodes immediately after removing them from the patient.
 - ◆ Peel off the adhesive foil before cleaning the electrodes (rests of the adhesive can be removed with benzine).
 - ◆ Then use warm water and a small brush to clean the electrodes of cream or gel. Do not use pointed or sharp objects for cleaning.
 - ◆ Disinfect the electrodes with alcohol-free disinfectant. Ensure that connectors and sockets do not become wet.
- The only approved sterilization method is gas sterilization.

Frequently sterilizing the electrodes with ethylene oxide gas reduces the life of the plastic material.

Maintenance

Checks Before Each Use

Before each use, visually inspect the device, the leads and electrodes for signs of mechanical damage.

If you detect damages or impaired functions that may adversely affect the safety of the patient or user, do not use the device before it has been repaired.

Technical Inspections

For safety, the devices require regular maintenance. To ensure functional and operational safety of the MAC 1200/1200 ST units, Technical Inspections should be carried out on an annual basis.

These checks should be performed by persons with adequate training and experience.

The checks can be carried out by GE Medical Systems *Information Technologies* within the framework of a service contract. The inspections include the following checks.

- Visually inspect the device and the accessories for signs of mechanical damage that may impair the device functions.
- Check that the device labeling relevant for safety is legible.
- Run a performance test as described in the operator's manual.
- Measure the resistance of the non-fused, earthed conductor and the equivalent leakage current as per local regulations.

The device does not require any other maintenance.



Disposal

At the end of their service life, the device described in this manual and its accessories must be disposed of in compliance with the applicable local waste control regulations. If you have questions regarding the disposal of the product or of the accessories, please contact GE Medical Systems *Information Technologies* or its representatives.

13 Troubleshooting

For your notes

Troubleshooting Chart

Symptom	Cause	Remedy
Periodic superimposition of AC line interference (50 Hz) (see figure below)	Interference from the power line	Ground bed, verify position of the leadwires, switch on AC line filter
Superimposition of irregular AC line interference (see figure next page)	Muscle artifact caused by patient movements, hiccup, coughing	The patient should be warm enough and resting comfortably (place cushions under arms and knees). Comfort or distract patient, enable muscle filter (20 Hz / 40 Hz), if necessary.
The printed date and time are incorrect	Built-in lithium battery is depleted. The battery has a life of approximately 5 years	Notify service to check and/or replace battery
The green indicator does not light up, although the recorder is connected to the power line	Defective AC power adapter or fuse	Notify service to check and/or replace fuse
The recorder does not write over the entire paper width	Paper compartment not properly closed	Paper door must lock into place on both sides
In Automatic mode, the recorder does not stop and continues to feed paper. This does not happen in Manual mode.	The paper pad was inserted the wrong way round so the recorder cannot detect the cue mark	Insert the paper pad as instructed
Recorder does not start after activation of the   key, or the recording is aborted.	Unit operated on battery power: battery discharged	Connect recorder to the power line. After a few minutes, the recorder is able to resume operation. Always connect recorder to the power line when indicator lights up. The battery capacity depends on age, temperature and charge level. (See Chapter 3, "Operating and Performance Tests" for details.)
No recording in Automatic mode	Failure of at least one electrode	Check all electrodes or enable Override function. (See Chapter 10, "Automatic Mode" section for details).
Paper jam		Open paper compartment and removed jammed sheet, place beginning of paper between the marks, close paper compartment and press  .



054A

Regular AC Line Interference

NOTE

In the presence of very strong AC line interference in all leads, the thermal printhead may interrupt the recording. Activate the AC line filter (50 Hz/60 Hz) in these situations.

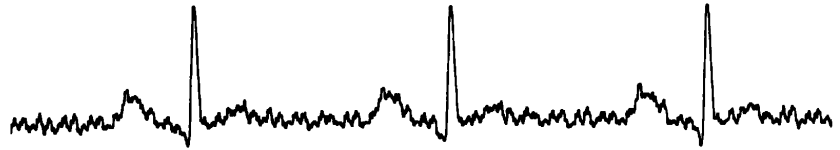

054A

Irregular AC Interference

14 Technical Specifications

For your notes

Recording

Direct recording of waveforms and alphanumeric characters with rectangular coordinates by means of thermal-array printhead printing on thermosensitive paper.

- 3 or 6 recording channels, or 12 in Automatic mode, overlapping
- Baseline pitch:
 - 6 channels: 31 mm (manual)
 - 12 channels: 16 mm (automatically)
- Writing width 200 mm maximum
- Annotation of recorder settings, date, time and entered patient name in the margin of the recording strip.
- With appropriate software, documentation of analysis results in the respective operating mode.
- Resolution of the recording:

Vertical	8 dots/mm
Horizontal	25 μ m at 25 mm/s

Printer Paper

CONTRAST[®] / ARCHIVIST[®] Z-fold pad, 150 pages per pad, equivalent to a chart length of approximately 45 m

Paper width: 210 mm or 8.5 inch (215.9 mm; US format)

Sheet length: 297 mm or 11 inch (279.4 mm; US format)

To prevent damage to the printhead use only the original CONTRAST[®] / ARCHIVIST[®] paper.

Paper Transport

- Paper speed
 - 5-25-50 mm/s, key selectable
 - Error limits at 25 and 50 mm/s, typical \pm 1%
at 5 mm/s, \pm 10% max.
- At paper end, the recorder emits an audio signal and stops recording. The last pages of the pad bear a colored stripe in the lower margin.

Membrane Keypad

Pushbuttons with tactile feedback.

- Function keys for all routine operations.
- Alphanumeric keyboard for entry of text.

Display

- Graphics display with 24 x 40 characters, contrast adjustment.
- Resolution of 320 x 240 pixels with display backlighting.

Indicators (LEDs)

For mains power, battery status, and start/stop function.

Lead Selection

Manual selection of different lead combinations or automatic lead sequencing.

- Lead programs (configurable):
 - ◆ EINTHOVEN, GOLDBERGER, WILSON, NEHB,
 - ◆ CABRERA lead sequence and user-specific combinations in Manual and Arrhythmia modes

Automatic Functions

They assist and facilitate operation by the following:

- Automatic amplifier blocking
- Automatic control of lead selection, paper feed, calibration (configurable)
- Report formatting (configurable)
- Automatic baseline adjustment
- Anti-drift system compensating for polarization voltage fluctuations (configurable)

Detection of Pacer Pulses

- Pulse length between 0.1 and 2.5 ms
- Pacer pulse marker independent of pulse polarity
- Pulse amplitude between ± 5 mV and ± 700 mV

Heart Rate Indication

Derivation of the heart rate from all ECG signals.

- Display range 30 to 300 bpm
- Display update with every heart beat, maximum every 2 seconds

Signal Inputs

Isolated patient signal input, IEC type CF, high-voltage protection for all lead connections and neutral electrode, interference compensation via neutral electrode, monitoring for open leads.

- Electrode connections for R, L, F, N, Cl ... C6, Nax, Nst, Nap (= C4).
- Input impedance for differential signals between any two electrode connections > 10 MW at 10 Hz.
- Input impedance for common-mode signals referred to neutral electrode > 50 MW up to 60 Hz.
- Dynamic range for differential signals between any two electrode connections for AC voltage ± 10 mV, for superimposed DC voltage (polarization voltage) ± 600 mV.
- Dynamic range for common-mode signals referred to neutral electrode ± 1 V, referred to chassis 263 V AC (rms).
- Quiescent input current via any electrode connection for 1 kW termination referred to neutral electrode < 50 nA.
- Patient leakage current (rms values) according to IEC, class CF: in normal condition < 10 mA, in single-fault condition (e.g. patient in contact with line voltage) < 20 mA.
- Non-destructive range for lead-electrode connections and the neutral electrode connection referred to neutral electrode ± 50 V, referred to chassis ± 1500 V.
- Pulse voltage resistance of all lead electrode connections and of the neutral electrode connection referred to chassis (either polarity, e.g. defibrillation) 5000 V.
- Monitoring of each electrode for open leads: R, L, F, N, Cl, C2, C3, C4, C5, C6, Nap, Nax, Nst. Audible lead fail signal at program start.

Data Interface

One serial RS232 interface for exchange of data with suitable peripheral devices and software handshake.

RS232 interface (standard V.24 interface)

- Input voltage range. $\pm 15V$ maximum
- Output voltage range $\pm 5 V$ minimum
- Interface protected from electrostatic discharge for $\pm 10 kV$ maximum

Transfer of ECGs with the CSI Protocol Between the MAC 1200 and the Following Units

MUSE CVIS	SW version 004A and later
MAC 5000	SW version 001B and later
MAC VU	SW version 002A and later
MAC 1200	SW version V5.01 and later

Receiving Data with the CSI Communication Protocol from the Following Units

CardioSmart	SW version V4.21 and later
CardioSmart ST	SW version V4.21 and later

Sending ECGs to the Following Units with the A5 Protocol

CardioSys / CardioSoft SW version V1.0 and later

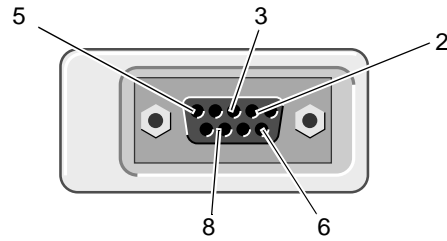

104A

Pin Assignment of Data Port	
2	RDXE
3	TDXE
5	Circuit reference
6	Modem supply
8	RDXE

Remote Start (Hardware)

Paper feed via remote control connection (depending on selected operating mode). External make contact referred to chassis via circuit reference.

- Source impedance $R_i < 300 \Omega$
- Contact dwell $> 100 \text{ ms}$
- Non-destructive load $\pm 10 \text{ V}$
- ESD interface protection up to $\pm 10 \text{ kV}$

Signal Transmission

Patient Input to Recording

After lead formation and digitization simultaneous transmission of all electrode signals to the digital processing system; muscle filter, AC filter, pacing pulse identification, automatic or manual sensitivity adjustment, automatic baseline adjustment and drift compensation by means of the anti-drift system (A.D.S.) can be enabled or disabled simultaneously for all channels; digital output of processed signals via thermal-array printhead.

- Low cut-off frequency (-3 db limits) 0.08 Hz, equivalent to a time constant of 2.04 seconds.
- High cut-off frequency (3 dB limits) operating mode: Auto, Manual 150 Hz (IEC/AHA) operating mode: Arrhy 100 Hz (IEC).
- Signal sampling rate: 1000 per second
- Resolution, referred to the input 5 μ V
- Output rate to recorder 2000 per second
- For all leads, gain adjustment in four steps: 40-20-10-5 mm/mV.
- With active muscle filter (low-pass characteristic) 3-dB drop of the amplitude frequency response at approximately 40 or 20 Hz.
- With active AC line filter detection and compensation of periodic 50 Hz or 60 Hz frequency components (depending on recorder model) attenuation >40 dB.
- Non-linear distortion below values specified in IEC and AHA recommendations.
- Coincidence error limits between any two channels $\pm 0,5$ mm.
- Detection of pacer pulses in C2 or other C leads and marking in all channels for signals referred to patient input.
Duration ≥ 0.1 ms, amplitude > 5 mV
- Noise in the signal transmission path below values specified in IEC and AHA requirements: $\leq 2,5$ μ V rms.
- Common-mode rejection for 50 or 60-Hz signals (depending on recorder model) with AC filter switched on >140 dB.

ECG Calibration

Automatic recording of a defined voltage step, valid for all channels.

- Calibration voltage, referred to ECG signal input: 1 mV
Calibration pulse width on recording depends on paper speed
 - 25 mm/s 5 mm
 - 50 mm/s 10 mm
 - 5 mm/s 1 mm

Automatic ECG Gain Adjustment

The gain automatically adapts to the incoming signal. The maximum amplitude of the lead group or of all leads determines the gain setting.

- Automatic adjustment range 5 ... 40 mm/mV
- Amplitude range (6 channels) 18 to 31 mm

Baseline

Automatic adjustment of the baseline to the optimal recording range, in dependence of the signal amplitude.

Anti-drift System (ADS)

Automatic compensation of baseline fluctuations caused by polarization voltage fluctuations at the lead electrodes (delay in recording: 4.2 seconds).

ECG Storage

In Automatic mode, storage of approximately 40 ECGs.

- Stored ECGs can be deleted (individually or all in one pass), printed, transferred and patient data can be edited.
- In Arrhythmia mode, storage of up to 6 event episodes.

Blocking

Rapid charge reversal of the coupling capacitors in the preamplifiers after electrode application.

Electrode Monitoring

Audible and visual indication on the LCD of disconnected electrodes or line break; each single electrode is monitored.

Text Input

Patient and user data as well as comments can be entered via the panel keyboard and are annotated on the recording strip.

Copy Function

In Automatic mode, after ECG recording, copies of the ECG can be printed from memory and/or transferred to a connected PC (configurable).

Test

Automatic performance test upon power up, including verification of the signal path starting at the signal input.

Stored test data for demonstration of the device functions.

Power Supply

From the power line or from a built-in rechargeable battery, automatic switchover; automatic battery charging during line-power operation from integrated AC adapter module.

Mains Operation

- Instrument design in protection class I according to IEC 60601-1
- Rated voltage range 95 to 240 V
- Operating voltage range 85 to 264 V, 49 to 65 Hz
- Rated current 0.2 to 0.6 A
- Fuse: 2 x T (slow-blow) 1.25 A, 5x20
- Typical power consumption – battery charging 14 W
- Maximum power consumption 29 W

Battery Operation

- Type: nickel-cadmium
- Rated battery voltage 18 V
- Rated battery capacity 1.3 Ah
- Fully charged battery sufficient for up to 50 Automatic mode 1-page ECGs, provided recorder is only switched on to record the ECGs.
- Charge time for depleted battery approximately 4 hours (minimum charge time for 1 Automatic mode ECG: 10 minutes)
- Battery life approximately 2 to 3 years, replacement by service only
- Lithium battery for built-in clock, battery life approximately 5 years, replacement by service only

Battery Maintenance

The battery in the MAC 1200/1200 ST unit should be exercised regularly. This means the battery should be allowed to drain between charging cycles.

If the ECG unit is left connected to wall power and/or only used sporadically on battery power, a discharge cycle should be performed on a monthly basis.

Turn the MAC 1200/1200 ST unit on, and allow the battery to drain. When the Battery Low indicator illuminates, the unit can be connected to wall power and allowed to recharge.

Use a battery maintenance chart to track the discharge cycles

Operational Readiness

After successful self-test, approximately 10 seconds after power-up.

Operating Position

Horizontal

Environment

Operation

- Temperature between +10 and +40 °C
- Relative humidity between 25 and 95%
- Atmospheric pressure between 700 and 1060 hPa

Transport and Storage

- Temperature between -30 and +60 °C (including battery)
- Relative humidity between 25 and 95%
- Atmospheric pressure between 500 and 1060 hPa

Recorder Dimensions

- Width 370 mm
- Height 95 mm
- Depth 320 mm (include handle)

Weight

Recorder with battery approximately 5.6 kg

15 Order Information

For your notes

General Information

Subject to change. Always refer to latest list of accessories.

Options

455 045 01	ECG Measurement MEAS (MAC 1200 / MAC 1200 ST)
455 046 01	ECG Measurement and Interpretation DIAG (MAC 1200 / MAC 1200 ST)
455 050 01	Upgrade "Interpretation" (if MEAS is already implemented)
455 044 01	Memory (for 40 resting ECGs) MEMO (MAC 1200 / MAC 1200 ST)
455 052 01	Stress Test ERGO (MAC 1200 ST)

General Accessories

Patient Cables

223 418 08	Patient trunk cable, 10-lead, IEC (MultiLink)
223 418 09	Patient trunk cable, 10-lead, AHA (MultiLink)
384 018 16	Set of leadwires, 4 mm connector, 10 leads, defibrillator proof, IEC
384 018 17	Set of leadwires, 4 mm connector, 10 leads, defibrillator proof, AHA

Electrodes

217 225 03	Adhesive electrodes for babies, 13 mm diameter, with 4 mm socket, 60 cm lead, fixation with adhesive rings 927 224 00
217 110 03	Adhesive electrodes for children, 22 mm diameter, with 4 mm socket, fixation with adhesive rings 217 123 01
217 320 01	Adhesive electrodes for children, 22 mm diameter, with press stud, fixation with adhesive rings 217 123 01
217 321 01	Adhesive electrodes for adults, 35 mm diameter, with press stud, fixation with adhesive rings 927 223 00

504 648 56	Limb lead electrode for adults (stainless steel plate electrode), 31 x 40 mm, with 4 mm socket
923 096 47	Rubber strap for electrode 504 648 56 and 301340 00
301 340 00	Button-shaped electrode for adults, 30 mm diameter, with 4 mm socket
217 194 01	Chest electrode for electrode belt, 30 mm diameter
217 196 01	Electrode belt for electrodes 21719401 and 301340 00
217 144 01	Chest suction electrode, 22 mm diameter, small suction bulb, with 4 mm socket
217 144 02	Chest suction electrode, 22 mm diameter, large suction bulb, with 4 mm socket
919 202 32	Clip electrode for limb leads, package of 4 electrodes (red, yellow, green, black)
303 442 96	Adapter for connection of electrodes with press stud to patient cable with 4 mm connector

ECG Accessories, NEHB

223 403 05	Patient trunk cable, 12 leads, NEHB, IEC
384 017 65	Set of leadwires, 10 leads, defibrillation-proof, IEC, with 4 mm plug
384 017 66	Set of leadwires, 2 leads, NEHB, IEC, with 4 mm plug (in addition to 384 017 65), defibrillation-proof

Consumables

226 166 11	ARCHIVIST writer paper, non-fading, A4, package of 10 pads
226 166 05	CONTRAST writer paper, A4, package of 10 pads
226 166 06	CONTRAST writer paper, B4, package of 10 pads
217 083 06	Electrode gel, 10 tubes, 100 ml each
217 083 05	Electrode cream, 10 tubes, 100 ml each
217 083 18	Electrode cream, refill, 250 ml

217 083 14	Electrode cream, 5-l container
930 115 82	Dispenser, 30 ml
217 307 01	Electrode contact spray, 200 ml bottle
217 307 05	Electrode contact spray, 2-l refill
927 224 00	500 adhesive rings for electrodes 217 225 ..
217 123 01	500 adhesive rings for electrodes 217 320 .., 217 110 ..
927 223 00	500 adhesive rings for electrodes 217 321..
217 007 03	Electrode paper, 200 sheets, for electrode 504 648 56
217 148 01	Electrode paper, 200 sheets, for electrode 217 144 01/02
217 043 02	ECG filing cards (50 cards)

Electrode Application Systems

216 121 13	Electrode Application System KISS 10 (10-lead system, without pump)
216 124 13	Electrode Application System KISS 10 (10-lead system, with pump)
216 122 02	Electrode Application System KISS 12 (12-lead system NEHB, without pump)
303 443 77	Swivel arm for KISS
384 015 84	Table-top clamp with pole
384 013 30	Wall fixture for swivel arm
303 444 21	Clip adapter for adhesive electrodes

Miscellaneous

931 098 80	Instrument bag
227 477 02	Physician's Guide for ECG Interpretation Program HEART V4.3, English
416791-004	12SL ECG-Analysis Program Physician's Guide

217 041 02	ECG ruler (GUTZER)
919 062 00	Power cord, 3 m
401855-107	Power cord CH, 3 m
919 203 37	Power cord UK, 3 m
919 201 81	Power cord US, 2.5 m

Connection Cables

2020187-001	Global modem kit
2008683-001	Connection cable (MAC 1100/MAC 1200 to modem, 9-pin) (Available separately or as part of the global modem kit.)
223 362 03	Connection cable (MAC 1100 / MAC 1200 to CardioSys)
223 378 01	Connection cable (MAC 1100 / MAC 1200 to modem, 9-pin)
223 378 02	Connection cable (MAC 1100 / MAC 1200 to modem, 25-pin)
223 362 03	Connection cable (EC 560 / ECB 561 or MAC 1100/MAC 1200 to CardioSys)
223 330 04	Connection cable (M700 to MAC 1100/MAC 1200)
223 366 04	Connection cable (EC 1200 to MAC 1100 / MAC 1200)
2006795-001	Connection cable (Variobike 500 to MAC 1200 ST)
2006796-001	Connection cable (Lode Excalibur to MAC 1200 ST)
223 390 03	Connection cable (T2000 to MAC 1200 ST)
223 368 02	Connection cable (TM400 to MAC 1200 ST)

A Entering Special Characters

For your notes

Special Characters

The following special characters (not for the Czech language) can be entered by means of the appropriate keystroke combination.

Character	Keystroke Combination
\	Alt + Q
@	Alt + W
#	Alt + E
\$	Alt + R
&	Alt + Y
ı	Alt + D
-	Alt + F
Ç	Alt + G
Å	Alt + K
Ü	Alt + L
î	Alt + X
Ñ	Alt + C
	Alt + V
Ø	Alt + B
Ö	Alt + N
Ä	Alt + M
Á	Alt + I, then A
É	Alt + I, then E
Í	Alt + I, then I
Ó	Alt + I, then O
Ú	Alt + I, then U
À	Alt + O, then A (enter È, Ì, Ò, Û in the same manner)
Â	Alt + P, then A (enter Ê, Î, Ô, Û in the same manner)
ÿ	Alt + U, then Y (enter Ý, Ä, Ö, Û in the same manner)
Ã	Alt + H, then A (enter Ñ, Ò in the same manner)
Ð	Alt + A
Æ	Alt + J
Z	Alt + T, then Z
Š	Alt + T, then S
i	Alt + X

For your notes

Index

-
- A**
AC line filter, stress test 10-5, 10-18
AC line frequency 10-23
AC line interference 13-3
Activating Options 10-31
Aging stability (recordings) 11-6
Anti-drift system 4-9, 10-10
Arrhythmia Codes 7-9
Audience, manual's 1-4
authorized service 1-12
Automatic baseline adjustment 4-9
Automatic mode 5-3
- B**
Batch Transmission 5-12
Battery, charging 3-3
Baud rate 10-26
Bicycle ergometer protocols 8-4
Biocompatibility 1-11
Blood pressure intervals 8-9
Blood pressure monitors 8-9
- C**
CE marking CE-1
Cleaning 12-1
Connecting the patient cable 4-3
Contrast, adjustment 3-6
Controls and indicators 2-3
Create new protocol 10-17
- D**
Date 10-22
Detailed results 5-11, 10-4
device
 name 1-12
Disinfection 12-1
Display backlighting 10-23
Disposal of the device 12-4
- E**
EC 1200 8-9
ECG recording during defibrillation 9-4
ECG storage 5-3
ECG transmission to MUSE 5-16
ECG transmission via modem 5-14
ECGs, receive 5-18
Electrode application 4-4
Electrode application points 4-5
Electrode, disconnected 5-5
EMC requirements 1-9
End of writer paper 11-5
Entering patient data 4-11
Ergoline 500, 800, 900/900L 8-9
Ergometer type, select 10-28
Ergometers with digital communication interface 8-9
Ergometers with remote start pulse 8-8
- Ergometers without Digital Communication Interface 8-6
Explosion hazard 1-7
- F**
Final report 7-8, 10-12
Final report, stress test 8-22
- G**
Global measurement points 5-21
- H**
Heart rate limit 6-6
Host system 10-6
how to
 read label 1-12
- I**
Indicators 2-3
Installation 3-4
- L**
Language 10-24
Lead fail beep 10-22
Lead labels 10-22
Literature 1-11
Lithium battery 13-3
Local T offset measurement point 5-23
Lode excalibur 8-9
- M**
Maintenance 12-4
Master step beep 10-23
Master step test, protocol 8-16
Master's step protocols, create custom protocols 8-17
Master's step test, user intervention 8-15
Master's step tests 8-4, 8-14
Measurement points, adjust 5-21
Medication 4-15
MEMO option 5-3
Modem 5-12
Multiple portable socket outlets 1-8
Muscle artifact 10-5
Muscle filter 10-5
Muscle Filter, Stress Test 10-5
Muscle filter, stress test 10-18
MUSE database 3-10
- N**
name of device 1-12
Nehb 4-7
- O**
Option Code 10-31
Option MEMO 5-3
Options 10-31
Ordering physician 4-14
Override function 10-7
-

-
- P**
- Pacemaker, patient 9-3
 - Packaging material, disposal 1-9
 - Paper feed, automatic 10-10
 - Paper jam 13-3
 - Paper, inserting new pad 11-3
 - Password protection (setup menu) 10-24
 - Patient cable, connection 4-3
 - Patient Data Setup 10-29
 - Patient data, entry 4-11
 - Performance check 3-5
 - Peripheral equipment, connection 3-9
 - Physician, referring, ordering 4-14
 - Physician, referring, ordering 10-21
 - Plate electrodes 4-4
 - Power supply 3-3
 - product code 1-12
 - Program sequence for ergometers with digital interface 8-10
 - Program sequence for ergometers without digital interface 8-8
 - Program sequence for treadmill test 8-13
 - Prompts 10-30
 - Protection class 1-4
 - Protocol editor 10-13
 - Protocol, new 10-17
 - Protocols for data communication 10-26
 - Protocols, create custom protocols 8-17
 - Protocols, reactivate factory defaults 10-18
- Q**
- QT dispersion 5-23
- R**
- Receiving ECGs 5-18
 - Recharging the battery 3-3
 - Recording problems 4-9
 - Referring physician 4-14
 - Remote start pulse 8-7, 8-8
 - Report formats 5-10
 - Revision history 1-5
 - Rhythm leads 10-4
- S**
- Self test, abort 3-5
 - serial number 1-12
 - service
 - information 1-12
 - requirements 1-12
 - Setup menu, stress test 8-5
 - Software Version CE-2
 - Specifications 14-1
 - Standard leads 4-5
 - Stress test mode, setup 10-13
 - Stress test, end 8-21
 - Stress test, running a test 8-18
 - Suction electrodes 4-4
 - Symbols, explanation 2-6
 - System defaults 10-24
 - System setup 10-21
 - System version CE-2
- T**
- T offset measurement point 5-23
 - Technical specifications 14-1
 - Test DATA 10-24
 - Time 10-22
 - Time stamp 5-12
 - Transport 1-9
 - Treadmill 8-12
 - Treadmill protocols 8-4
 - Trend recording 10-12
 - Troubleshooting 13-1
- U**
- Units 10-23
- W**
- Warranty 1-6



GE Medical Systems
Information Technologies



gemedical.com

World Headquarters
GE Medical Systems
Information Technologies, Inc.
8200 West Tower Avenue
Milwaukee, WI 53223 USA
Tel: + 1 414 355 5000
1 800 558 5120 (US only)
Fax: + 1 414 355 3790

European Representative
GE Medical Systems
Information Technologies GmbH
Munzinger Straße 3-5
D-79111 Freiburg
Germany
Tel: + 49 761 45 43 - 0
Fax: + 49 761 45 43 - 233

Asia Headquarters
GE Medical Systems
Information Technologies Asia; GE (China) Co., Ltd.
24th Floor, Shanghai MAXDO Center,
8 Xing Yi Road, Hong Qiao Development Zone
Shanghai 200336, P.R. China
Tel: + 86 21 5257 4650
Fax: + 86 21 5208 2008